

LightTech 2009

LightTech



2008

SBK WORLD CHAMPION

1° TROY BAYLISS • TEAM DUCATI XEROX

4° MAX NEURCHIRKNER • SBK • TEAM SUZUKI ALSTARE

2007

3° MAX BIAGGI • SBK • TEAM SUZUKI ALSTARE

3° FABIEN FORET • SUPERSPORT • TEAM GIL MOTORSPORT

4° KATSUAKI FUJIWARA • SUPERSPORT • TEAM HONDA ALTHEA

1° ALVARO BAUTISTA • 125 GP • TEAM ASPAR

3° ALEX DE ANGELIS • 250 GP • TEAM ASPAR

1° ALEX POLITA • STOCK 1000 • TEAM CELANI

2006

2° JAMES TOSELAND • SBK • TEAM HONDA TEN KATE

4° TROY CORSER • SBK • TEAM SUZUKI ALSTARE

2005

1° TROY CORSER • SBK • TEAM SUZUKI ALSTARE

2° CHRIS VERMEULEN • SBK • TEAM HONDA TEN KATE

1° SEBASTIEN CHARPENTIER • SUPERSPORT • TEAM HONDA TEN KATE

2002

2° KATSUAKI FUJIWARA • SUPERSPORT • TEAM SUZUKI ALSTARE

3° STEPHANE CHAMBON • SUPERSPORT • TEAM SUZUKI ALSTARE

LighTech products are available from:



Optimum Performance Products

US Warehouse Facility

**Optimum Performance Products
1160 Yew Avenue
Blaine, WA, USA
98230**

**Phone: 604.942.6744
Fax: 604.942.6745**

Canada Retail Facility

**Optimum Performance Products
101B - 1952 Kingsway Avenue
Port Coquitlam, BC, Canada
V3C 6C2**

**Email: info@oppracing.com
Website: www.oppracing.com**

PEDANE / REAR SETS	3
regolabili / adjustable rear sets	4
fisse/ fixed rear sets	6
componenti ricambio / rear sets spare parts	7
tenditori catena / chain adjusters	10
supporti cavaletto/ swing arm stand brackets	11
LEVE / LEVERS	13
leve freno / brake levers	14
ricambi leve freno / brake levers spare parts	18
leve frizioni / clutch levers	20
contrappesi manubrio / handlebar balancers	22
accessori per manubri / handlebar holders accessories	24
PORTA TARGA / NUMBER PLATE SUPPORT	25
regolabili / adjustable	26
fissi/ fixed rear sets	28
fanalini targa a LED/ light with LED	29
frecce a LED / indicator with LED	30
piastrine frecce/ plaque for direction indicator	31
KIT portatarga / adjustable number plate supports KIT	32
VITERIA / SCREWS	35
ergal 7075	36
titanio / titanium	38
forate / drilled	40
autofilettanti ergal 7075 / ergal 7075 self tapping screws	41
special ergal 7075 / 7075 ergal special	42
viti dischi freno in titanio / screws for brake disk in titanium	44
dadi / nuts	46
rondelle / washers	47
ganci rapidi e ricettacoli / quick fairing and receptacle	48
DADI SPECIAL/ SPECIAL NUTS	49
MINI GP HONDA	57
TAPPI / CAPS	59
tappi serbatoio / fuel caps	60
tappi olio / oil filter plugs	62
valvola sfiato benzina e sfiato olio per Ducati / breathing valve and engine oil breather for Ducati	63
coperchi / covers	64
regolatori molla / fork spring adjusters	66
SERBATOIO RIFORNIMENTO FUEL CANISTER	67
SPECCHIETTI / MIRRORS	71
in carbonio / carbon mirrors	72
in alluminio per naked / aluminium mirrors for naked	73
tappo specchio Yamaha T-Max / mirror cover Yamaha T-Max	74
PROTEZIONI / PROTECTIONS	75
protezioni telaio / frame protections	76
protezioni perni ruota / wheel axle protections	79
RACCORDERIA / BRAKE PARTS	77
tubi freno Lucas / lucas brake hose	86
CAVALLETTI / STANDS	89
KIT VITI / SCREWS KIT	95
starter kit	103
kit viti tappo serbatoio / fuel tank cap screws kit	104
kit viti cupolino / windscreen screws kit	105
VETRORESINA E CARBONIO FIBERGLASS AND CARBON PARTS	107
SAPONETTE / KNEE SLIDERS	114
ACCESSORI / ACCESSORIES	115
CONDIZIONI GENERALI DI VENDITA / SALES CONDITIONS	116



Sistema Qualità Certificato Quality System Guarantee
UNI EN ISO 9001 - Cert. N. 501003736/1

listino prezzi • price list



PEDANE
REAR SETS

MODELLO model	ANNO year		CAMBIO ROVESCIAIO reverse shifting	CODICE code
	DAL from	AL to		
DUCATI				
DUCATI 749-999			OK	FTR02D999
DUCATI 1098-848	07	08	OK	FTR02D1098
HONDA				
HONDA CBR 600	03	06	OK	FTR02CBR605S
HONDA CBR 600	07	08	OK	FTR02CBR607
HONDA CBR 1000	04	07	OK	FTR02CBR104
HONDA CBR 1000	08		OK	FTR02CBR108
HONDA CB 1000R	08		—	FTRH0001
KAWASAKI				
KAWASAKI ZX6R	05	08	OK	FTR02KZX605
KAWASAKI ZX10R	04	05	OK	FTR02KZX1004
KAWASAKI ZX10R	06	07	OK	FTR02KZX1006
KAWASAKI ZX10R	08		OK	FTR02KZX1008
MV				
MV Brutale + MV F4			—	FTRBRUTALE
(gruppo senza leve) / (inside there aren't levers: use the originals)				
SUZUKI				
SUZUKI GSXR 600	01	05	OK	FTR02GSXR604
SUZUKI GSXR 750	00	05	OK	FTR02GSXR604
SUZUKI GSXR 1000	01	04	OK	FTR02GSXR604
SUZUKI GSXR 600/750	06	08	OK	FTR02GSXR606
SUZUKI GSXR 1000	05	06	OK	FTR02GSXR105
SUZUKI GSXR 1000	07	08	OK	FTR02GSXR107
TRIUMPH				
TRIUMPH Speed Triple 955 (per cambio rovesciato no cavalletto laterale/for reverse shifting not central stand)	00	04	OK	FTR02SPEED04
TRIUMPH Speed Triple 1050 (per cambio rovesciato no cavalletto laterale/for reverse shifting not central stand)	05	08	OK	FTR02SPEED05
YAMAHA				
YAMAHA R6	03	05	OK	FTR02YR603
YAMAHA R6	06	08	OK	FTR02YR608
YAMAHA R1 (asta esterna al telaio/external rod from frame)	04	06	OK	FTR02YR104
YAMAHA R1	07	08	OK	FTR02YR107
YAMAHA FZ1	06	08	OK	FTR02YF1

MODELLO model	ANNO year		CAMBIO ROVESCIAIO reverse shifting	CODICE code
	DAL from	AL to		
DUCATI				
DUCATI 749-999			OK	FTR02D999W
DUCATI 1098-848	07	08	OK	FTR02D1098W
HONDA				
HONDA CBR 600	03	06	OK	FTR02CBR605SW
HONDA CBR 600	07	08	OK	FTR02CBR607W
HONDA CBR 1000	04	07	OK	FTR02CBR104W
HONDA CBR 1000	08		OK	FTR02CBR108W
HONDA CB 1000R	08		—	FTRH0001W
KAWASAKI				
KAWASAKI ZX6R	05	08	OK	FTR02KZX605W
KAWASAKI ZX10R	04	05	OK	FTR02KZX1004W
KAWASAKI ZX10R	06	07	OK	FTR02KZX1006W
KAWASAKI ZX10R	08		OK	FTR02KZX1008W
MV				
MV Brutale + MV F4			—	FTRBRUTALEW
(gruppo senza leve) / (inside there aren't levers: use the originals)				
SUZUKI				
SUZUKI GSXR 600	01	05	OK	FTR02GSXR604W
SUZUKI GSXR 750	00	05	OK	FTR02GSXR604W
SUZUKI GSXR 1000	01	04	OK	FTR02GSXR604W
SUZUKI GSXR 600/750	06	08	OK	FTR02GSXR606W
SUZUKI GSXR 1000	05	06	OK	FTR02GSXR105W
SUZUKI GSXR 1000	07	08	OK	FTR02GSXR107W
TRIUMPH				
TRIUMPH Speed Triple 955 (per cambio rovesciato no cavalletto laterale/for reverse shifting not central stand)	00	04	OK	FTR02SPEED04W
TRIUMPH Speed Triple 1050 (per cambio rovesciato no cavalletto laterale/for reverse shifting not central stand)	05	08	OK	FTR02SPEED05W
YAMAHA				
YAMAHA R6	03	05	OK	FTR02YR603W
YAMAHA R6	06	08	OK	FTR02YR608W
YAMAHA R1 (asta esterna al telaio/external rod from frame)	04	06	OK	FTR02YR104W
YAMAHA R1	07	08	OK	FTR02YR107W
YAMAHA FZ1	06	08	OK	FTR02YF1W

HONDA CBR



YAMAHA R6



KAWASAKI ZX6R



SUZUKI 600/750



MODELLO
model

ANNO year
DAL AL
from to
CAMBIO ROVESCIAIO
reverse shifting
CODICE
code

HONDA

HONDA CBR 600	03	06	OK	FRSCBR605S
HONDA CBR 600	07	08	OK	FRSH002
HONDA CBR 1000	04	07	OK	FRSCBR104
HONDA CBR 1000	08		OK	FRSH001

KAWASAKI

KAWASAKI ZX6R	05	08	OK	FRSKZX605
---------------	----	----	----	-----------

SUZUKI

SUZUKI GSXR 1000	05	06	OK	FRSGSXR105
------------------	----	----	----	------------

YAMAHA

YAMAHA R1	04	06	OK	FRSR104
YAMAHA R6	06	08	OK	FRSR606



PUNTALINO / FRONT PEG
RFTR52



POGGIA PIEDE SNODATO FISSAGGIO SU PIASTRA
FOLD UP FOOTPEG FIXING ON SUPPORT
RFTR72



POGGIA PIEDE-FISSAGGIO SU LEVA A CUSCINETTI
FOOTPEG FIXING ON BEARINGS LEVER
RFTR32



ASTA mm. / ROD mm.



POGGIA PIEDE-FISSAGGIO SU PIASTRA
FOOTPEG FIXING ON SUPPORT
RFTR45



UNIBALL

MAS M6 dx = VARIO36
MAS M6 sx = VARIO77

FEM M6 dx = VARIO95
FEM M6 sx = VARIO76



POGGIA PIEDE SNODATO FISSAGGIO SU LEVA A CUSCINETTI / FOLD UP FOOTPEG FIXING ON BEARINGS LEVER
RFTR71



INTERRUTTORE STOP IDRAULICO (M10 X 1,25)
/ HYDRAULIC STOP SWITCH (M10 X 1,25)
RFTR93

COMPONENTI OPTIONAL PER PEDANE
optional components for rear sets

ARRETRATORI PEDANE
rear sets adapter plates

ANNO year

CODICE
code

a coppia
/for pair

HONDA CBR 1000
HONDA CBR 600
SUZUKI GSXR 1000
KAWASAKI ZX6R

DAL from	AL to
04	08
03	08
05	06
05	08

ARPCBR104
ARPCBR104
ARPGSXR105
ARPKZX605



PARATTACCO
heel plate



FTR 280 alluminio/aluminium



FTR 281 carbonio/carbon



FTR 282 alluminio/aluminium



FTR 283 carbonio/carbon



TENDITORI CATENA chain adjusters



MODELLO model	ANNO year		CODICE code	a coppia /for pair
	DAL from	AL to		
HONDA CBR 600	07	08	TEH607	
HONDA CBR 1000	06	07	TEH107	
HONDA CBR 1000	08		TEH607	
KAWASAKI ZX6R	07	08	TEZX607	
KAWASAKI ZX10R	08		TEZX108	
SUZUKI GSXR 600/750	06	08	TESK7	
SUZUKI GSXR 1000	07	08	TESK7	
YAMAHA R6	06	08	TEY608	
YAMAHA R1	07	08	TEY107	

Colori disponibili: oro, indaco, rosso, nero.
Available colours: gold, indigo, red, black.

FORCHETTE TENDITORI CATENA lifters for chain adjusters



MODELLO model	ANNO year		CODICE code	a coppia /for pair
	DAL from	AL to		
HONDA CBR 600	07	08	FTEH607	
HONDA CBR 1000	08		FTEH607	
KAWASAKI ZX6R	07	08	FTEZX607	
KAWASAKI ZX10R	08		FTEZX108	
SUZUKI GSXR 600/750	06	08	FTESK7	
SUZUKI GSXR 1000	07	08	FTESK7	
YAMAHA R1	07	08	FTEY107	

SUPPORTI PER CAVALLETTI swing arm stand brackets



MISURA measure	CODICE code	a coppia /for pair
M8	CAVM8	
M10 X 1,50	CAVM1015	
M10 x 1,25	CAVM10	

CAVM1015 solo in silver e nero.
CAVM1015 only in silver or black.

TROFEO
SUZUKI CUP

GSX
EUROPEAN CUP



LEVE
LEVERS



ER GAL 7075



MAGNESIO



COLORI DISPONIBILI: NERO / AVAILABLE COLOURS: BLACK	ANNO / year		CODICE code
	DAL from	AL to	
BREMBO			
BREMBO (16 x 16) LEVA CORTA / SHORT LEVER			LEVDE551
BREMBO (16 x 18) (19 x 18)			LEVDE502
BREMBO (16 x 18) (19 x 18) LEVA CORTA / SHORT LEVER			LEVDE552
BREMBO (19 x 20)			LEVDE503
BREMBO (19 x 20) LEVA CORTA / SHORT LEVER			LEVDE553
APRILIA RSV 1000	04	08	LEVDE001
DUCATI 999-749	02	06	LEVDE001
HONDA CBR 954		03	LEVDE002
HONDA CBR 600		04	LEVDE002
HONDA CBR 600	05	08	LEVDE003
HONDA CBR 1000	04	08	LEVDE003
HONDA CB 1000 R	08		LEVDE006
KAWASAKI ZX6R		04	LEVDE004
KAWASAKI ZX6R	05	08	LEVDE005
KAWASAKI Z750	04	06	LEVDE004
KAWASAKI Z1000	03	06	LEVDE004
KAWASAKI Z1000	07	08	LEVDE005
KAWASAKI ZX10R	04	05	LEVDE004
KAWASAKI ZX10R	06	08	LEVDE005
SUZUKI tutte / all		03	LEVDE004
SUZUKI GSXR 600/750	04	08	LEVDE006
SUZUKI GSXR 1000		04	LEVDE004
SUZUKI GSXR 1000	05	08	LEVDE006
TRIUMPH SPEED TRIPLE 1050	05	07	LEVDE004
TRIUMPH SPEED TRIPLE 1050	08		LEVDE006
TRIUMPH STREET TRIPLE 675	07	08	LEVDE008
TRIUMPH DAYTONA 675	07	08	LEVDE006
YAMAHA R1		03	LEVDE004
YAMAHA R1	04	08	LEVDE007
YAMAHA R6		04	LEVDE004
YAMAHA R6	05	08	LEVDE007

COLORI DISPONIBILI: NERO / AVAILABLE COLOURS: BLACK	ANNO / year		CODICE code
	DAL from	AL to	
BREMBO			
BREMBO (16 x 16) LEVA CORTA / SHORT LEVER			LEVDM551
BREMBO (16 x 18) (19 x 18)			LEVDM502
BREMBO (16 x 18) (19 x 18) LEVA CORTA / SHORT LEVER			LEVDM552
BREMBO (19 x 20)			LEVDM503
BREMBO (19 x 20) LEVA CORTA / SHORT LEVER			LEVDM553
APRILIA RSV 1000	04	08	LEVDM001
DUCATI 999-749	02	06	LEVDM001
HONDA CBR 954		03	LEVDM002
HONDA CBR 600		04	LEVDM002
HONDA CBR 600	05	08	LEVDM003
HONDA CBR 1000	04	08	LEVDM003
HONDA CB 1000 R	08		LEVDM006
KAWASAKI ZX6R		04	LEVDM004
KAWASAKI ZX6R	05	08	LEVDM005
KAWASAKI Z750	04	06	LEVDM004
KAWASAKI Z1000	03	06	LEVDM004
KAWASAKI Z1000	07	08	LEVDM005
KAWASAKI ZX10R	04	05	LEVDM004
KAWASAKI ZX10R	06	08	LEVDM005
SUZUKI tutte / all		03	LEVDM004
SUZUKI GSXR 600/750	04	08	LEVDM006
SUZUKI GSXR 1000		04	LEVDM004
SUZUKI GSXR 1000	05	08	LEVDM006
TRIUMPH SPEED TRIPLE 1050	05	07	LEVDM004
TRIUMPH SPEED TRIPLE 1050	08		LEVDM006
TRIUMPH STREET TRIPLE 675	07	08	LEVDM008
TRIUMPH DAYTONA 675	07	08	LEVDM006
YAMAHA R1		03	LEVDM004
YAMAHA R1	04	08	LEVDM007
YAMAHA R6		04	LEVDM004
YAMAHA R6	05	08	LEVDM007

ERGal 7075



MAGNESIO



COLORI DISPONIBILI: NERO / AVAILABLE COLOURS: BLACK	ANNO / year		CODICE code
	DAL from	AL to	
BREMBO			
BREMBO (16 x 16) LEVA CORTA / SHORT LEVER			LEVSE551
BREMBO (16 x 18) (19 x 18)			LEVSE502
BREMBO (16 x 18) (19 x 18) LEVA CORTA / SHORT LEVER			LEVSE552
BREMBO (19 x 20)			LEVSE503
BREMBO (19 x 20) LEVA CORTA / SHORT LEVER			LEVSE553
APRILIA RSV 1000	04	08	LEVSE001
DUCATI 749-999	02	06	LEVSE001
HONDA CBR 954		03	LEVSE002
HONDA CBR 600		04	LEVSE002
HONDA CBR 600	05	08	LEVSE003
HONDA CBR 1000	04	08	LEVSE003
HONDA CB 1000 R	08		LEVSE006
KAWASAKI ZX6R		04	LEVSE004
KAWASAKI ZX6R	05	08	LEVSE005
KAWASAKI ZX10R	04	05	LEVSE004
KAWASAKI ZX10R	06	08	LEVSE005
KAWASAKI Z750	04	06	LEVSE004
KAWASAKI Z1000	03	06	LEVSE004
KAWASAKI Z1000	07	08	LEVSE005
SUZUKI tutte / all		03	LEVSE004
SUZUKI GSXR 600/750	04	08	LEVSE006
SUZUKI GSXR 1000		04	LEVSE004
SUZUKI GSXR 1000	05	08	LEVSE006
TRIUMPH SPEED TRIPLE 1050	05	07	LEVSE004
TRIUMPH SPEED TRIPLE 1050	08		LEVSE006
TRIUMPH STREET TRIPLE 675	07	08	LEVSE004
TRIUMPH DAYTONA 675	07	08	LEVSE006
YAMAHA R6		04	LEVSE004
YAMAHA R6	05	08	LEVSE007
YAMAHA R1		03	LEVSE004
YAMAHA R1	04	08	LEVSE007

COLORI DISPONIBILI: NERO / AVAILABLE COLOURS: BLACK	ANNO / year		CODICE code
	DAL from	AL to	
BREMBO			
BREMBO (16 x 16) LEVA CORTA / SHORT LEVER			LEVSM551
BREMBO (16 x 18) (19 x 18)			LEVSM502
BREMBO (16 x 18) (19 x 18) LEVA CORTA / SHORT LEVER			LEVSM552
BREMBO (19 x 20)			LEVSM503
BREMBO (19 x 20) LEVA CORTA / SHORT LEVER			LEVSM553
APRILIA RSV 1000	04	08	LEVSM001
DUCATI 749-999	02	06	LEVSM001
HONDA CBR 954		03	LEVSM002
HONDA CBR 600		04	LEVSM002
HONDA CBR 600	05	08	LEVSM003
HONDA CBR 1000	04	08	LEVSM003
HONDA CB 1000 R	08		LEVSM006
KAWASAKI ZX6R		04	LEVSM004
KAWASAKI ZX6R	05	08	LEVSM005
KAWASAKI ZX10R	04	05	LEVSM004
KAWASAKI ZX10R	06	08	LEVSM005
KAWASAKI Z750	04	06	LEVSM004
KAWASAKI Z1000	03	06	LEVSM004
KAWASAKI Z1000	07	08	LEVSM005
SUZUKI tutte / all		03	LEVSM004
SUZUKI GSXR 600/750	04	08	LEVSM006
SUZUKI GSXR 1000		04	LEVSM004
SUZUKI GSXR 1000	05	08	LEVSM006
TRIUMPH SPEED TRIPLE 1050	05	07	LEVSM004
TRIUMPH SPEED TRIPLE 1050	08		LEVSM006
TRIUMPH STREET TRIPLE 675	07	08	LEVSM004
TRIUMPH DAYTONA 675	07	08	LEVSM006
YAMAHA R6		04	LEVSM004
YAMAHA R6	05	08	LEVSM007
YAMAHA R1		03	LEVSM004
YAMAHA R1	04	08	LEVSM007

ATTENZIONE: I KIT VENGONO FORNITI CON LEVA CORTA ART. LEV09031. PER AVERLA CON LEVA LUNGA ART. LEV09030 AGGIUNGERE ALLA FINE DEL CODICE LA LETTERA L.
 ATTENTION: THE KIT HAVE SHORT LEVER ART. LEV09031. TO HAVE LONG LEVER ART. LEV09030 WRITE AT THE END OF THE CODE THE LETTER L.

ATTENZIONE: I KIT VENGONO FORNITI CON LEVA CORTA ART. LEV09031. PER AVERLA CON LEVA LUNGA ART. LEV09030 AGGIUNGERE ALLA FINE DEL CODICE LA LETTERA L.
 ATTENTION: THE KIT HAVE SHORT LEVER ART. LEV09031. TO HAVE LONG LEVER ART. LEV09030 WRITE AT THE END OF THE CODE THE LETTER L.

COLORI DISPONIBILI: NERO / AVAILABLE COLOURS: BLACK

ARTICOLO
article

CODICE
code



LEVA FRENO LUNGA LEV09030
in ERGAL 7075

7075 ERGAL
LONG BRAKE LEVER



LEVA FRENO CORTA LEV09031
in ERGAL 7075

7075 ERGAL
SHORT BRAKE LEVER



LEVA FRENO LUNGA LEV09030S
IN MAGNESIO

MAGNESIUM
LONG BRAKE LEVER



LEVA FRENO CORTA LEV09031S
IN MAGNESIO

MAGNESIUM
SHORT BRAKE LEVER

COLORI DISPONIBILI: NERO / AVAILABLE COLOURS: BLACK

ARTICOLO
article

CODICE
code



POMELLO RLEV001
DI REGOLAZIONE

ADJUSTMENT'S KNOB



CAVO DI REGOLAZIONE
ADJUSTMENT'S CABLE

NISSIN RLEV005
BREMBO APRILIA RSV 1000 >04 RLEV008
BREMBO DUCATI 749-999 RLEV008
BREMBO YAMAHA R1 >04 RLEV008
BREMBO RLEV009



REGISTRO RLEV006
BRAKE ADJUSTER



SUPPORTO REGISTRO RLEV007
BRAKE ADJUSTER SUPPORT

COLORI DISPONIBILI: NERO / AVAILABLE COLOURS: BLACK

CODICE
code



LEVA FRIZIONE RIBALTABILE A CAVO IN ERGAL 7075
7075 ERGAL FOLDING CLUTCH LEVER (for cable clutch lever)

LEV7100

LEVA FRIZIONE RIBALTABILE A CAVO in MAGNESIO
MAGNESIUM FOLDING CLUTCH LEVER (for cable clutch lever)

LEV7100S



LEVA FRIZIONE BREMBO 18 x 18 IN ERGAL 7075
FOLDING BREMBO CLUTCH LEVER 18 x18 in 7075 ergal

LEV7200

LEVA FRIZIONE BREMBO 18 x 18 in MAGNESIO
MAGNESIUM FOLDING BREMBO 18 x18 CLUTCH LEVER

LEV7200S

APRILIA RSV 1000 - DUCATI 749 - 999 - 1098 in MAGNESIO/MAGNESIUM

LEV7300S

SUZUKI GSXR 1000 K7 in MAGNESIO/MAGNESIUM

LEV7400S

COLORI DISPONIBILI: NERO / AVAILABLE COLOURS: BLACK

ARTICOLO
article

CODICE
code



LEVA PER ART.
LEV7100

LEV7010

LEVER FOR
ART. LEV7100



LEVA PER ART.
LEV7100S
LEV7200S
LEV7300S
LEV7400S

LEV7010S

LEVER FOR ART.
LEV7100S
LEV7200S
LEV7300S
LEV7400S



REGISTRO LEVA
FRIZIONE

LEV7016

CLUTCH LEVER
ADJUSTER



LEVA PER
ART. LEV7200

LEV7018

LEVER FOR
ART. LEV7200

CONTRAPPESI MANUBRIO

handlebar balancers

CONTRAPPESI MANUBRIO LISCI

smooth handlebar balancers



MOTO bike	ANNO year		MISURA measure	COD. code	a coppia /for pair
	DAL from	AL to			
UNIVERSALE/UNIVERSAL			12 mm	KTM12	
UNIVERSALE/UNIVERSAL			17 mm	KTM17	
APRILIA RSV 1000				KTMA	
APRILIA Tuono	03	08		KTMA	
DUCATI S4-ST2				KTMK2	
DUCATI Multistrada	03	08		KTMS	
DUCATI 848	08			KTM12	
DUCATI 1098	07	08		KTM17	
GUZZI GRISO	05	08		KTMS	
HONDA				KTMH	
KAWASAKI Z750	04	08		KTMK2	
KAWASAKI Z1000	03	08		KTMK2	
KAWASAKI ZX6R	03	08		KTMK2	
KAWASAKI ZX10R	04	08		KTMK4	
SUZUKI GSR 600	06	08		KTMS	
SUZUKI GSXR 600/750	00	05		KTMS	
SUZUKI GSXR 600/750	06	08		KTMS2	
SUZUKI GSXR 1000	03	04		KTMS	
SUZUKI GSXR 1000	05	08		KTMS2	
YAMAHA Fazer 600 - FZ6	04	06		KTMY	
YAMAHA Fazer 1000	01	08		KTMY	
YAMAHA T Max	02	08		KTMY	
YAMAHA TDM 900	02	08		KTMY	
YAMAHA FZ1	06	08		KTMF	
YAMAHA MT-03	06	08		KTMMT	
YAMAHA R1	98	08		KTM1	
YAMAHA R6	00	05		KTMR6	
YAMAHA R6	06	08		KTM1	

UNIVERSALE / UNIVERSAL			17 mm	KTM172	
TRIUMPH SPEED TRIPLE 1050	08			KTM172	



MOTO bike	ANNO year		MISURA measure	COD. code	a coppia /for pair
	DAL from	AL to			
UNIVERSALE/UNIVERSAL			12 mm	KTM0212	
UNIVERSALE/UNIVERSAL			17 mm	KTM0217	
DUCATI S4-ST2				KTM02K2	
DUCATI Multistrada	03	08		KTM02S	
DUCATI 848	08			KTM0212	
DUCATI 1098	07	08		KTM0217	
GUZZI GRISO	05	08		KTM02S	
HONDA				KTM02H	
KAWASAKI Z750	04	08		KTM02K2	
KAWASAKI Z1000	03	08		KTM02K2	
KAWASAKI ZX6R	03	08		KTM02K2	
KAWASAKI ZX10R	04	08		KTM02K4	
SUZUKI GSR 600	06	08		KTM02S	
SUZUKI GSXR 600/750	00	05		KTM02S	
SUZUKI GSXR 600/750	06	08		KTM02S2	
SUZUKI GSXR 1000	03	04		KTM02S	
SUZUKI GSXR 1000	05	08		KTM02S2	
YAMAHA Fazer 600 - FZ6	04	06		KTM02Y	
YAMAHA Fazer 1000	01	08		KTM02Y	
YAMAHA T Max	02	08		KTM02Y	
YAMAHA TDM 900	02	08		KTM02Y	
YAMAHA R1	98	08		KTM021	
YAMAHA R6	00	05		KTM02R6	
YAMAHA R6	06	08		KTM021	



MOZZETTI / handlebar holders

H. 0 mm



CODICE
code

a coppia
/for pair

Ø 43 + 10 MM	MOZ4310	
Ø 45 + 10 MM	MOZ4510	
Ø 48 + 10 MM	MOZ4810	
Ø 50 + 10 MM	MOZ5010	
Ø 53 + 10 MM	MOZ5310	

Ø 43 + 20 MM	MOZ4320	
Ø 45 + 20 MM	MOZ4520	
Ø 48 + 20 MM	MOZ4820	
Ø 50 + 20 MM	MOZ5020	
Ø 53 + 20 MM	MOZ5320	

Colore: nero / Colour: black

H. 20 mm

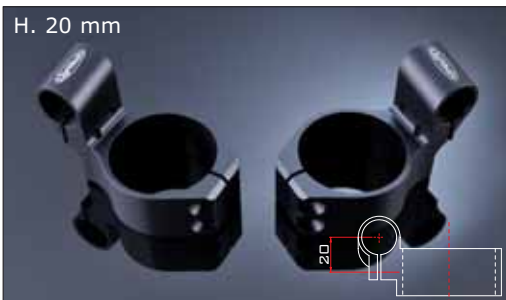

inclinazione 10°
inclination 10°

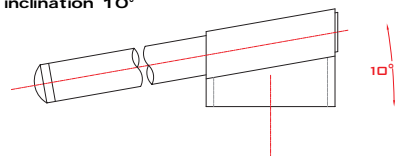

TUBI / handlebar tubes



MOZ1001

a coppia
/for pair

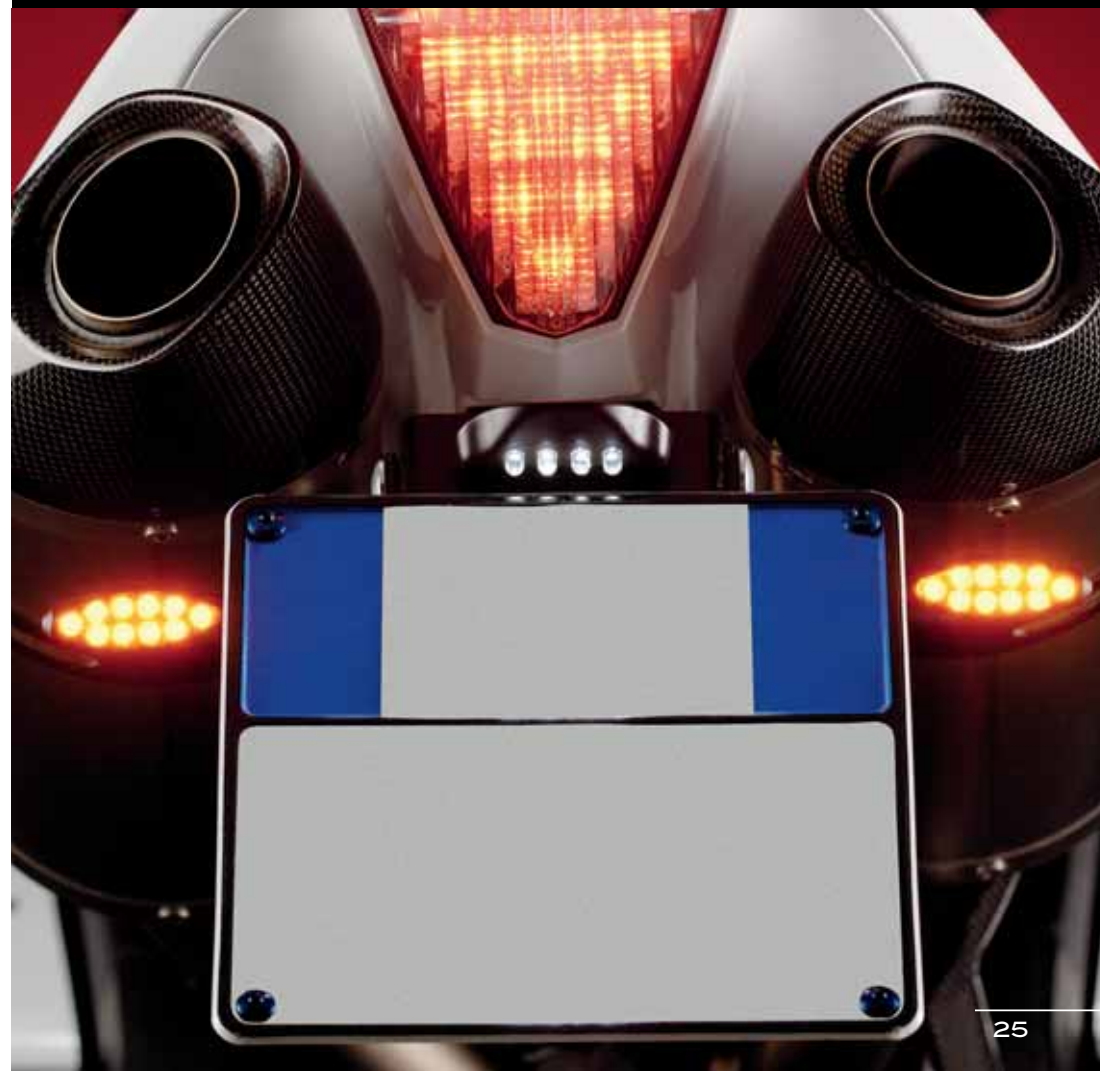

PORTA TARGA REGOLABILI
adjustable number plate supports

PORTA TARGA REGOLABILI
adjustable number plate supports

MODELLO model	ANNO year		A	B	C	D	E	CODICE code	N
	DAL from	AL to							
APRILIA									
APRILIA RSV 1000	04	05	x	—				PTRA04	---
APRILIA Tuono	06	07	x	—				PTRA04	---
BENELLI									
BENELLI TNT			x	x				PTRB04	---
DUCATI									
DUCATI MONSTER	03	04			x			PTRDMONSTER	---
DUCATI 749-999	02	06			x			PTRD999	---
DUCATI 1098 - 848	07	08	x	x	x			PTRD1098	---
DUCATI HYPERMOTARD 1100	07	08	x	x	x			PTRDHYP	---
GUZZI									
MOTO GUZZI GRISO	06	07	x	x	x			PTRGG	---
HONDA									
HONDA HORNET 600	07	08	x	x				PTRHH607	---
HONDA CBR 600	05	06	x	x	x			PTRH04	---
HONDA CBR 600	07	08	x	x	x			PTRH607	---
HONDA CBR 600	07	08	x	x	x			PTRHCBR608	---
HONDA CBR 1000	04	05	x	x	x			PTRH04	---
HONDA CBR 1000	06	07	x	x	x			PTRH06	---
HONDA CBR 1000	08		x	—	x			PTR08H501	---
HONDA CB 1000 R	08		x	—	x			PTR08H502	---
KAWASAKI									
KAWASAKI ZX6R	03	04	x	x	x			PTRK06	---
KAWASAKI ZX6R	05	06	x	x				PTRK05	---
KAWASAKI ZX6R	07	08	x	x	x			PTRKZX607	---
KAWASAKI ZX6R	07	08	x	—	x			PTRKZX608	---
KAWASAKI ZX10R	04	05	x	x	x			PTRK04	---
KAWASAKI ZX10 R	06	07			x			PTRKZX1006	---
KAWASAKI ZX10 R	08		x	x				PTRKZX1008	---
KAWASAKI ER-6N	06	08	x	x	x			PTRK04	---
KAWASAKI Z 1000	03	06	x	x	x			PTRK06	---
KAWASAKI Z 750	04	06	x	x	x			PTRK06	---
KAWASAKI Z750+Z1000	07	08	x	x				PTRKZ7507	---

MODELLO model	ANNO year		A	B	C	D	E	CODICE code	N
	DAL from	AL to							
KTM									
KTM 690	07	08	x	x				PTRKTM690	---
MORINI									
MORINI CORSARO	06	08	x	x				PTRMC06	---
MV									
MV AGUSTA Brutale			x	x				PTRBRT	---
MV AGUSTA F4			x	x				PTRF4	---
SUZUKI									
SUZUKI GSXR 1000	05	08			x			PTRS05	---
SUZUKI GSXR 600-750	06	07			x			PTRS06	---
SUZUKI GSXR 600-750	08				x			PTRS08	---
SUZUKI GSR 600	06	08	x	x				PTRSGSR06	---
SUZUKI SV 650 - 1000	03	08	x	x				TARSU001	---
SUZUKI B-KING			x	x	x			PTRBKING	---
TRIUMPH									
TRIUMPH 1050 Speed Triple	05	07	x	x	x			PTRSPEED	---
TRIUMPH Street Triple 675	07	08	x	x	x			PTRTST607	---
TRIUMPH DAYTONA 675	07	08	x	x	—	x		PTR07T501	---
YAMAHA									
YAMAHA YZF-R 125	08		x	x	x			TARYA001	---
YAMAHA R6	06	08	x	x				PTRYR04	---
YAMAHA R6	06	08		x	x			PTRYR04	---
YAMAHA R1	04	08	x	x				PTRYR04	---
YAMAHA R1	04	08		x	x			PTRYR04	---
YAMAHA Fazer 600+FZ6	04	08	x	x	x			PTRYF6R	---
YAMAHA Fazer 600+FZ6	04	08		x	x			PTRYF6S	---
YAMAHA FZ1 + FAZER 1000	06	08	x	x	x			PTRYF1	---
YAMAHA MT-03	06	08	x	x				PTRYMT	---
YAMAHA T-MAX	04	07			—			PTRYTMAX	---
YAMAHA T-MAX	08				x			PTRYTMAX08	---



A = predisposizione montaggio freccia piccola / with hole for little indicator
 B = predisposizione montaggio freccia standard / with hole for standard indicator
 C = predisposizione montaggio luce targa Ligtech / with hole for Ligtech number plate support's light
 D = con faro posteriore / with rear stop position light
 E = con luce targa Ligtech cod. PTLA2 / with Ligtech rear light code PTLA2

N = desinenza nazione da aggiungere al codice
 add the abbreviation of Nationality to the code

IT = Italia F = Francia
 P = Portogallo SLO = Slovenia
 E = Spagna CA = Canada
 CH = Svizzera USA = Stati Uniti
 AUS = Australia

A = predisposizione montaggio freccia piccola / with hole for little indicator
 B = predisposizione montaggio freccia standard / with hole for standard indicator
 C = predisposizione montaggio luce targa Ligtech / with hole for Ligtech number plate support's light
 D = con faro posteriore / with rear stop position light
 E = con luce targa Ligtech cod. PTLA2 / with Ligtech rear light code PTLA2

N = desinenza nazione da aggiungere al codice
 add the abbreviation of Nationality to the code

IT = Italia F = Francia
 P = Portogallo SLO = Slovenia
 E = Spagna CA = Canada
 CH = Svizzera USA = Stati Uniti
 AUS = Australia

PORTA TARGA FISSI (DISPONIBILI SOLO IN ITALIA)
fixed number plate supports (only for Italy)

FANALINO TARGA A LED
light for number plate support

MODELLO model	ANNO year		A B C D E					CODICE code
	DAL from	AL to	A	B	C	D	E	
HONDA								
HONDA HORNET 600	03	06	x	x				PTHH603
YAMAHA								
YAMAHA XT 600X-600R-660R			x					PTYXT

A = predisposizione montaggio freccia piccola / with hole for little indicator
 B = predisposizione montaggio freccia standard / with hole for standard indicator
 C = predisposizione montaggio luce targa Lighttech / with hole for Lighttech number plate support's light
 D = con faro posteriore / with rear stop position light
 E = con luce targa Lighttech cod. PTLA2 / with Lighttech rear light code PTLA2

ACCESSORI PORTATARGA
number plate accessories

ARTICOLO article	CODICE code
---------------------	----------------



COPERTURE LATERALI PER LO SCARICO
(consigliabile per scarichi non originali)

EXHAUST PROTECTION
(suitable for not original exhausts)

PTHSUP01

ADATTABILE A PTRH04

Nota: Montando le coperture, per il CBR 600 (05) non sono necessari gli adattatori.
ADJUSTABLE ON PTRH04

Note: Assembling the protections, for CBR 600 (05) are not necessary the adaptors.

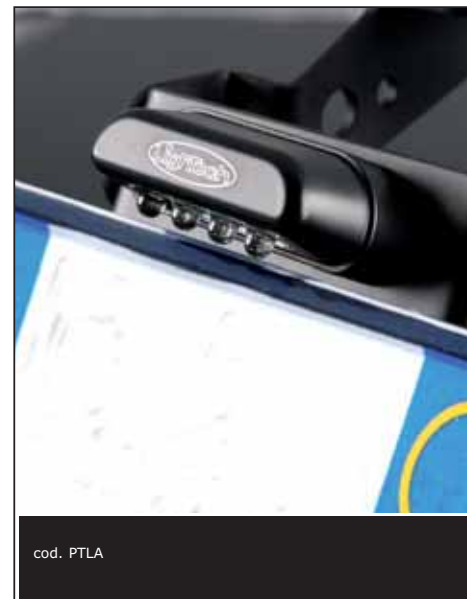

cod. PTLA



cod. PTLA2



cod. LT001



cod. LT003
senza copri faro / without cover



cod. LT002
con copri faro / with cover

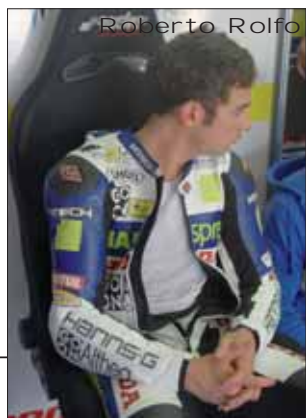

Roberto Rolfo



Troy Bayliss

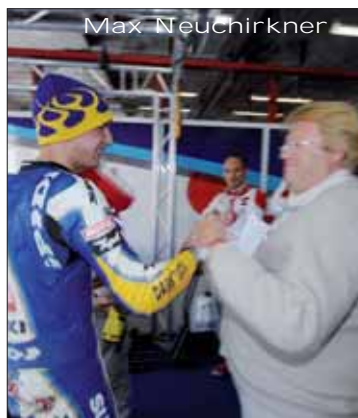

Max Neuchirkner

ARTICOLO
article

per 4 pezzi /for 4 pieces

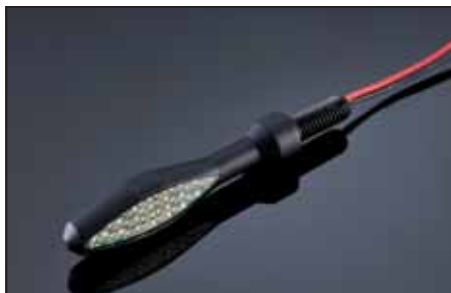

cod. FRE01
(nero/black)

a coppia / for pair



cod. FRE02
(nero/black)

OMOLOGATO 97-24-CE / APPROVED 97-24-CE

a coppia / for pair



cod. FRE903 C

OMOLOGATO E11 / APPROVED E11

a coppia / for pair



cod. FRE904 C

OMOLOGATO E11 / APPROVED E11

a coppia / for pair



cod. FRE903 L

OMOLOGATO E11 / APPROVED E11

a coppia / for pair



cod. FRE904 L

OMOLOGATO E11 / APPROVED E11

a coppia / for pair

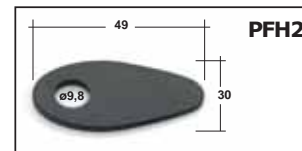
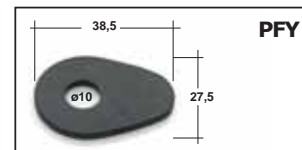

CATARIFRANGENTE CON STAFFA DI SUPPORTO
retroreflector with support bracket

CODICE
code



KAT01

a pezzo/for piece

MODELLO model	ANNO year		A	B	NO luce targa without rear light	CODICE code	N
	DAL from	AL to					
APRILIA							
APRILIA RSV 1000	04	05	x		x	28PTRA04	----
APRILIA TUONO	06	07	x		x	28PTRA04	----
BENELLI							
BENELLI TNT			x			28PTRB04	----
MV							
MV AGUSTA BRUTALE			x			28PTRBRT	----
MV AGUSTA F4			x			28PTRF4	----
DUCATI							
DUCATI 1098 - 848	07	08	x	x		28PTRD1098	----
DUCATI 749-999						28PTRD999	----
DUCATI HYPERMOTARD 1100	07	08	x	x		28PTRDHYPHER	----
DUCATI MONSTER						28PTRDMONSTER	----
GUZZI							
GUZZI GRISO	06	07	x	x		28PTRGG	----
HONDA							
HONDA CBR 600	05	06	x	x		28PTRH04	----
HONDA CBR 600	07	08	x	x	x	28PTRH607	----
HONDA CBR 1000	04	05	x	x		28PTRH04	----
HONDA CBR 1000	06	07	x	x		28PTRH06	----
HONDA HORNET 600	07	08	x			28PTRHH607	----
KAWASAKI							
KAWASAKI ER-6N	06	08	x	x		28PTRK04	----
KAWASAKI ZX6R	03	04	x	x		28PTRK06	----
KAWASAKI ZX6R	05	06	x			28PTRK05	----
KAWASAKI ZX6R	07	08	x	x		28PTRKZX607	----
KAWASAKI ZX10R	04	05	x	x		28PTRK04	----
KAWASAKI ZX10R	06	07				28PTRKZX1006	----
KAWASAKI ZX10R	08		x			28PTRKZX1008	----
KAWASAKI Z750 / Z1000	03	06	x	x		28PTRK06	----
KAWASAKI Z750 / Z1000	07	08	x			28PTRKZ7507	----
KTM							
KTM 690	07	08	x			28PTRKTM690	----
MORINI							
MORINI CORSARO	06	08	x			28PTRMC06	----
SUZUKI							
SUZUKI GSXR 600-750	06	07				28PTRS06	----
SUZUKI GSXR 600-750	08					28PTRS08	----
SUZUKI GSXR 1000	05	08				28PTRS05	----
SUZUKI GSR 600	06	08	x			28PTRSGSR06	----
SUZUKI SV 650 - 1000	03	08				28TARSU001	----
TRIUMPH							
TRIUMPH SPEED TRIPLE 1050	05	08	x	x		28PTRSPEED	----
TRIUMPH STREET TRIPLE 675	07	08	x			28PTRST607	----

A = predisposizione montaggio freccia piccola / with hole for little indicator
B = predisposizione montaggio freccia standard / with hole for standard indicator

MODELLO model	ANNO year		A	B	NO luce targa without rear light	CODICE code	N
	DAL from	AL to					
YAMAHA							
YAMAHA YZF-R 125	08		x	x		28TARYA001	----
YAMAHA R6	06	08	x			28PTRYR04	----
YAMAHA R6	06	08		x		28PTRYR04	----
YAMAHA R1	04	08	x			28PTRYR04	----
YAMAHA R1	04	08		x		28PTRYR04	----
YAMAHA FAZER 600 + FZ6	04	08	x			28PTRYF6R	----
YAMAHA FAZER 600 + FZ6	04	08		x		28PTRYF6S	----
YAMAHA FAZER 1000 + FZ1	06	08	x	x		28PTRYF1	----
YAMAHA MT-03	06	08	x			28PTRYMT	----
YAMAHA T-MAX	04	07			x	28PTRYTMAX	----
YAMAHA T-MAX	08					28PTRYTMAX08	----



N = desinenza nazione da aggiungere al codice
add the abbreviation of Nationality to the code

- IT = Italia
- P = Portogallo
- E = Spagna
- CH = Svizzera
- F = Francia
- SLO = Slovenia
- CA = Canada
- USA = Stati Uniti
- AUS = Australia

KIT PORTA TARGA FISSI CON CATADIOTRA E LUCE TARGA (DISPONIBILI SOLO IN ITALIA)
fixed number plate supports with retroreflector and rear light (only for Italy)

MODELLO model	ANNO year		A	B	NO luce targa without rear light	CODICE code
	DAL from	AL to				
HONDA						
HONDA HORNET 600	03		x			28PTH603
YAMAHA						
YAMAHA XT 600X-600R-660R			x		x	28PTYXT

CELANI RACE TEAM



VITERIA
SCREWS

TEAM CRUCIANI



TKR RACING TEAM



TEAM NEUGRIP



VITERIA ERGAL 7075

7075 ergal screws

COPIE DI SERRAGGIO
CONSIGLIATE PER LE VITI
TIGHTENING TORQUE

Ø	ERGAL 7075 T6
M.3	0.75 N.
M.4	1.50 N.
M.5	3.00 N.
M.6	5.20 N.
M.8	12.30 N.
M.10	25.00 N.
M.12	42,40 N.



LUNGHEZZA MM.
length mm.

	M4	M5	M6	M8	M10
10					-
15					-
20					-
25					-
30					-
35					-
40	-				-
45	-	-			-
50	-				-
55	-	-			-
60	-	-			-
65	-	-			-
70	-	-			-
75	-	-			-
80	-	-			-
85	-	-			-
90	-	-			-
95	-	-			-
100	-	-			-



L.
mm

	M4	M5	M6	M8	M10	M4	M5	M6	M8	M10
10	-			-	-					-
15	-			-	-					-
20	-			-	-					-
25	-			-	-					-
30	-			-	-					-
35	-			-	-					-
40	-	-		-	-					-
45	-	-		-	-					-
50	-	-	-	-	-					-
55	-			-	-					-
60	-			-	-					-
65	-			-	-					-
70	-			-	-					-
75	-			-	-					-
80	-			-	-					-
85	-			-	-					-
90	-			-	-					-
95	-			-	-					-
100	-			-	-					-

LE VITI CON DIAMETRO M10 SONO DISPONIBILI SOLO ART. 001 M10 x 1,5 E ART. 004 M10 x 1,25.
PER LUNGHEZZE SUPERIORI, SOLO SU ORDINAZIONE. QUANTITATIVO MINIMO 25 PZ.

Screws with diameter M10 are available only 001 M10 x 1,5 and art. 004 M10 x 1,25.
For superior length, only on required. Min. order 25 pcs.

COLORI DISPONIBILI
available colours

SILVER / SILVER



BLU / BLUE



INDACO / INDIGO



ROSSO / RED



NERO / BLACK



ORO / GOLD



VITI IN TITANIO GRADO 5

5TH degree titanium screws

COPIE DI SERRAGGIO
CONSIGLIATE PER LE VITI
TIGHTENING TORQUE

Ø	TIT. 6AV4V G5
M.3	1.73 N.
M.4	3.57 N.
M.5	6.90 N.
M.6	11.10 N.
M.8	28.30 N.
M.10	57.60 N.
M.12	97.50 N.



LUNGHEZZA MM. length mm.	M4	M5	M6	M8	M10
10					-
15					-
20					-
25					-
30					-
35					-
40					-
45					-
50					-
55					-
60					-
65	-				-
70	-				-
75	-	-			-
80	-	-			-
85	-	-			-
90	-	-			-
95	-	-			-
100	-	-			-
110	-	-			-
120	-	-			-
130	-	-			-
140	-	-			-
150	-	-			-



L. mm	M4	M5	M6	M8	M10	M4	M5	M6	M8	M10
10	-				-					-
15	-				-					-
20	-				-					-
25	-				-					-
30	-				-					-
35	-				-					-
40	-				-					-
45	-				-					-
50	-				-					-
55	-				-					-
60	-				-					-
65	-				-	-				-
70	-				-	-				-
75	-	-			-	-	-			-
80	-	-			-	-	-			-
85	-	-			-	-	-			-
90	-	-			-	-	-			-
95	-	-			-	-	-			-
100	-	-			-	-	-			-
110	-	-			-	-	-			-
120	-	-			-	-	-			-
130	-	-			-	-	-			-
140	-	-			-	-	-			-
150	-	-			-	-	-			-

PER M10 SPECIFICARE IL PASSO 1,25 o 1,5.
FOR M10 YOU HAVE TO SPECIFY THE PITCH 1,25/1,5.

PER M10 SPECIFICARE IL PASSO 1,25 o 1,5.
FOR M10 YOU HAVE TO SPECIFY THE PITCH 1,25/1,5.



MISURA measure	Ø	CODICE code
M5 x 15	12	FORM515
M5 x 20	12	FORM520
M6 x 15	17	FORM615
M6 x 20	17	FORM620
M6 x 25	17	FORM625
M6 x 30	17	FORM630
M8 x 20	22	FORM820
M8 x 30	22	FORM830
M8 x 40	22	FORM840
M8 x 45	22	FORM845

CODICE code	LUNGHEZZA length	Ø	Ø TESTA Ø head
PAC24513	13	4,5	10
PAC24516	16	4,5	10
PAC34513	13	4,5	14
PAC34516	16	4,5	14
PAC24913	13	4,9	10
PAC24916	16	4,9	10
PAC34913	13	4,9	14
PAC34916	16	4,9	14
PAC25516	16	5,5	10
PAC25519	19	5,5	10
PAC35516	16	5,5	14
PAC35519	19	5,5	14

VITI SPECIAL IN ERGAL 7075

7075 ergal special screws

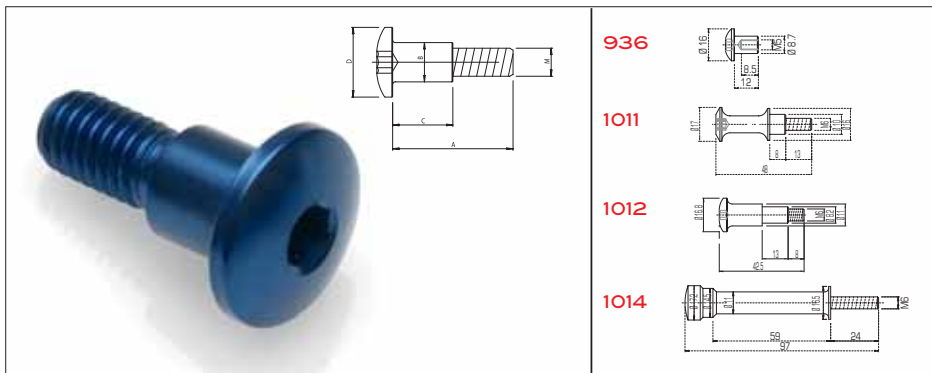

CODICE code	M	A	B	C	D
930	8	38,5	12,4	19	22
931	10	49	12,4	18,5	22
931B	10	38	12,4	19	22
932	4	12			9
933	6	19,5	7,5	3,5	14
934	10	56,5	11,9	22,5	19
935	8	38,5	11,9	22,5	19
936	5	12	8,7	12	16
940	6	17,4	8,3	8,4	17
941	5	15	7,4	7,5	12
950	6	20			10
951	8	31	10	6	17
952	8	41	9,9	6	16
953	8	20	9,9	5	17
954	6	30	6	9	10
955	6	23,5	9,9	11	20
956	6	15			10
960	8	33	9,9	11	15
961	10	25	9,9	4	15
962	5	16,5	8,1	3,7	14
963	6	20	7,9	9,5	18
964	7	17,5	10,9	5,5	24
965	6	15	7,9	3	14
970	4	21,5	4	5,5	10
971	4	7			10
972	6	11,5	8,2	3,75	14
974	6	15	9,85	5	22

CODICE code	M	A	B	C	D
976	6	19	7,9	8	14
977	6	30,5	8	23,5	14
978	6	15	7,9	6	14
979	6	13	6,9	4,4	14
980	6	14	7,9	3,8	14
981	5	15,6	7,9	2,6	14
982	6	16	8,4	3,5	14
983	6	15	7,9	6	17
984	6	15	8,9	4	14
991	6	30	6	11	12
992	6	11	9,9	3,5	17
993	5	10	8,9	3	14
994	6	14,5	9,4	6	17
995	6	14,5	11,9	3,5	17
997	6	15	8,9	5	14
998	6	15	9,9	3,5	17
999	5	15	7	2,5	11,5
1000	6	15	9	2	14
1001	5	20,5	7	13,5	12
1002	5	20,5	6,9	2,5	12
1003	6	11	8,2	4	14
1004	6	14	7,9	5,5	14
1005	6	15	9,8	5,5	22
1006	10	40	10	5	16
1007	6	20	6	1,5	30
1008	6	25,5	8	13,5	17
1009	5	25			9
1011	6	21	10	8	17
1012	6	21	8,25	13	17
1013	6	25,5	8	10,5	24
1014	MODIFICA CHIUSURA SELLA TRIUMPH / SPECIAL SCREW TO OPEN AND CLOSE THE TRIUMPH SEAT				
1015	5	16	8,2	8	14
1016	6	16,5	8,5	3,5	17
1018	6	16,5	8,2	5	12
1019	6	20	9,8	8,6	17
1020	5	17	8,2	5,8	14
1021	6	20	8,7	9,2	14

COLORI DISPONIBILI / available colours: INDACO / INDIGO, BLU / BLUE, NERO / BLACK, ORO / GOLD, ROSSO / RED, SILVER / SILVER



VITI DISCHI FRENO IN TITANIO GRADO 5
screws for brake disk in titanium 5 degree

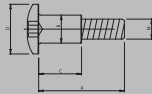

MOTO bike M A B C D CODICE code

KAWASAKI	8	31	10	5	18	VIT K
SUZUKI	8	33	10	10	16	VIT S
SUZUKI	8	21	9,9	6	16	VIT S2
DUCATI	8	15	—	—	13	VIT D1
DUCATI	8	20	—	—	13	VIT D2
HONDA ANT.	6	20	—	—	15	VIT H1
HONDA POST.	8	23	10	5	16	VIT H2
HONDA CR. ANT.	6	20	—	—	12	VIT H3
YAMAHA ANT.	6	21	8	6	14	VIT Y
YAMAHA POST.	8	20	9,8	4,5	16	VIT Y2

TROY BAYLISS
SBK world champion 2008





MISURA measure	ERGAL		
	0011	0015	0016
M4			-
M5			
M6			
M8			
M10 x 1,25		-	-
M10 x 1,5		-	-
M12 x 1,25		-	-

TITANIO TITANIUM
T0015

COLORI DISPONIBILI
available colours

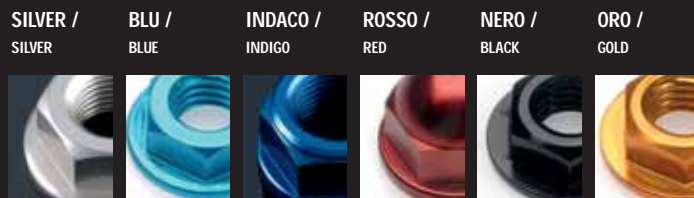

MISURA measure	Ø est. Ø ext.	SPESORE thickness	ERGAL	TITANIO TITANIUM
			CODICE code	CODICE code
M4	9	0,8	RM4	RM4T
M5	10	1,5	RM5	RM5T
M6	12	1,6	RM6	RM6T
M8	17	1,6	RM8	RM8T
M10	21	2	RM10	RM10T

RONDELLE SPECIALI / SPECIAL WASHERS

M4	16	1,6	RSM4	RSM4T
M5	17	1,6	RSM5A	RSM5AT
M5	21	1,6	RSM5B	RSM5BT
M6	17	1,6	RSM6A	RSM6AT
M6	21	1,6	RSM6B	RSM6BT
M6	30	2	RSM6C	RSM6CT
M8	21	2	RSM8A	RSM8AT
M8	30	2	RSM8B	RSM8BT
M10	30	2	RSM10	RSM10T

RONDELLE P.E.B.D. / WASHERS P.E.B.D.

M4	10	0,5	RPM4	-
M5	12	0,5	RPM5	-
M6	14	0,5	RPM6	-
M8	16	0,5	RPM8	-

RONDELLE INCASSATE CONICHE
WASHERS FOR CONICAL HEAD SCREWS

M5	15	4	RCM5	-
M6	22	4	RCM6	-
M8	25	5	RCM8	-

PIATTELLI
WASHERS



DUCATI	PIAD	-
KAWASAKI	PIAK	-

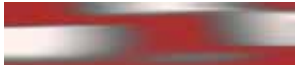

MISURA
measure

CODICE
code

CAPPELLETTO VALVOLA RUOTA
WHEEL VALVE CUP



VAL

GANCI RAPIDI IN ERGAL 7075
7075 ERGAL QUICK FAIRING FASTENERS

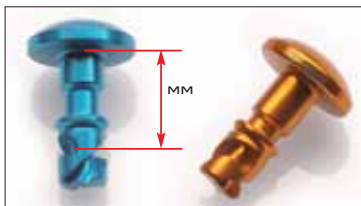

11 MM GR11

12 MM GR12

14 MM GR14

16 MM GR16

22 MM GR22

9 x 19 MM TØ20 GR91

GANCI RAPIDI IN FERRO
IRON QUICK FAIRING FASTENERS



11 MM GRFE11

12 MM GRFE12

14 MM GRFE14

RICETTACOLI
RECEPTACLE



RIC

**DADI
SPECIAL**
SPECIAL
NUTS

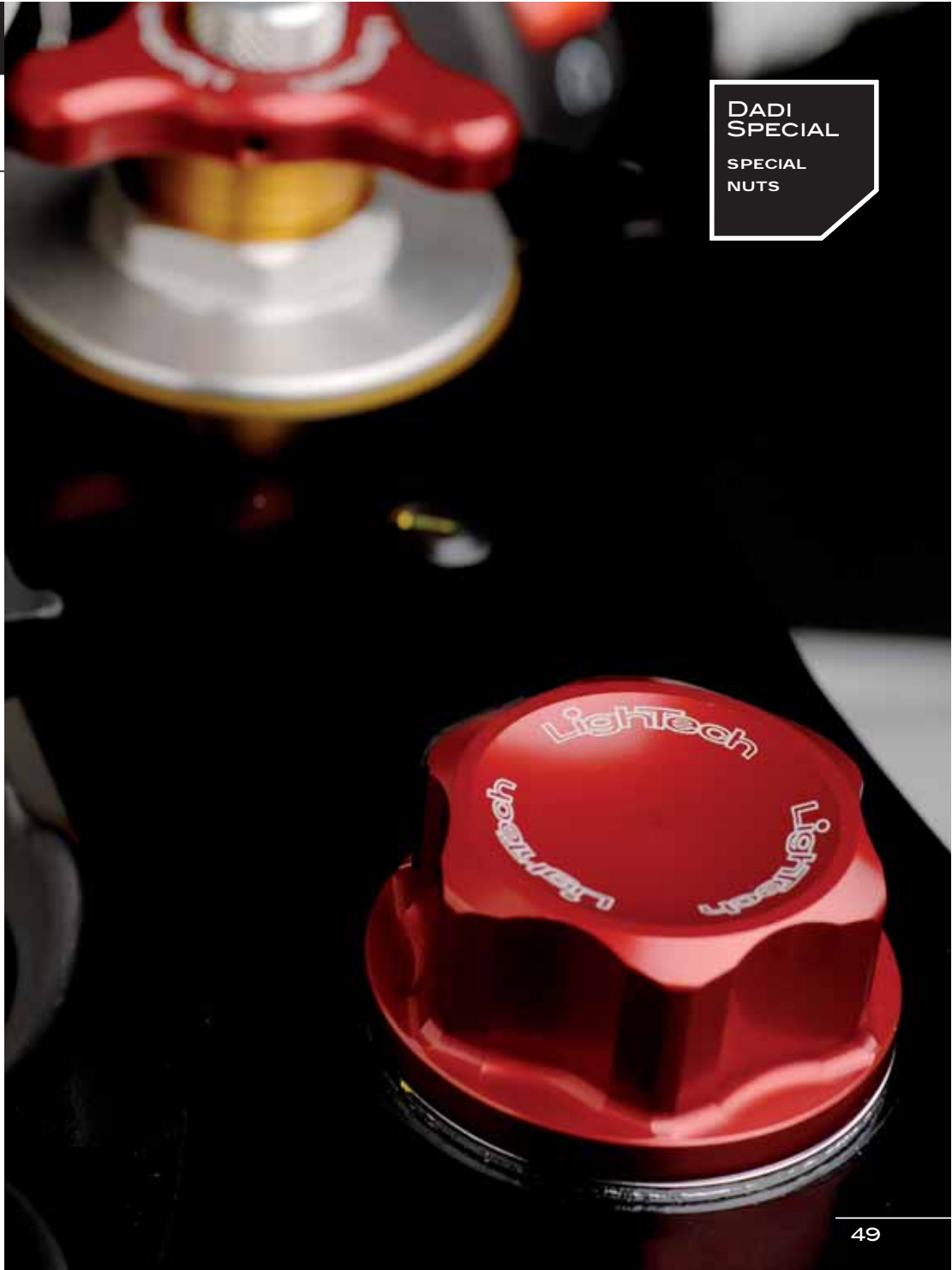

D001

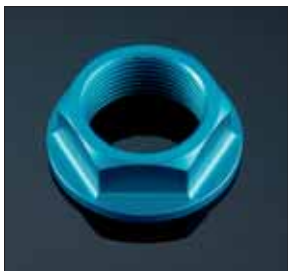

POSIZIONE position	MODELLO model	ANNO year		PASSO pitch
		DAL from	AL to	
Perno forcellone swing arm pivot shaft	SUZUKI GSXR 600/750	04	05	25 x 1,5
	SUZUKI GSXR 1000	03	04	
Perno ruota posteriore rear wheel axle	APRILIA RSV 1000	04	05	
	APRILIA Tuono	03	05	
	SUZUKI GSXR 600/750	04	08	
	SUZUKI GSXR 1000	03	08	
	SUZUKI SV 1000			
Perno ruota anteriore front wheel axle	APRILIA RSV 1000	04	05	
	GUZZI GRISO	05		
	DUCATI HYPERMOTARD 1100	07	08	

D004



POSIZIONE position	MODELLO model	ANNO year		PASSO pitch
		DAL from	AL to	
Perno ruota posteriore rear wheel axle	HONDA CB 1000 R	08		18 x 1,5
	HONDA Hornet 900	02	08	
	HONDA Hornet 600	07	08	
	KAWASAKI Z750	04	08	
	KAWASAKI ZX10	04	08	
	KAWASAKI ER-6N	06	08	
	SUZUKI SV 650	03	08	
	TRIUMPH STREET TRIPLE 675	07	08	
	TRIUMPH DAYTONA 675	07	08	
Perno forcellone swing arm pivot shaft	HONDA CBR 600	07	08	
	HONDA CBR 900	02	03	
	HONDA CB 1000 R	08		
	HONDA Hornet 600	07	08	
	SUZUKI SV 650	03	08	
	YAMAHA Fazer 600+FZ6	04	06	
	YAMAHA R1	04	06	
	YAMAHA R6	03	05	
	YAMAHA FZ1	06	08	

D002



POSIZIONE position	MODELLO model	ANNO year		PASSO pitch
		DAL from	AL to	
Canotto sterzo steering stem head	KAWASAKI ZX6R	03	04	25 x 1

D005



POSIZIONE position	MODELLO model	ANNO year		PASSO pitch
		DAL from	AL to	
Canotto sterzo steering stem head	YAMAHA Fazer 600+FZ6	04	06	22 x 1
	SUZUKI SV 650	99	02	
	YAMAHA MT-03	06	08	

D003

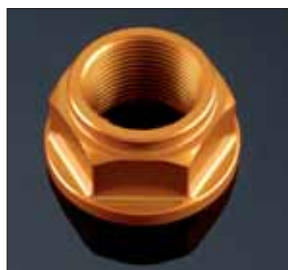

POSIZIONE position	MODELLO model	ANNO year		PASSO pitch
		DAL from	AL to	
Perno ruota posteriore rear wheel axle	KAWASAKI Z 1000	03	08	24 x 1,5
	KAWASAKI ZX6R	03	08	
	YAMAHA Fazer 600+FZ6	04	06	
	YAMAHA Fazer 1000+FZ1	01	08	
	YAMAHA R6	03	08	
	YAMAHA R1	04	08	
Perno ruota anteriore front wheel axle	KAWASAKI ZX10	06	07	

D006



POSIZIONE position	MODELLO model	ANNO year		PASSO pitch
		DAL from	AL to	
Canotto sterzo steering stem head	HONDA CBR 600	03	08	24 x 1
	HONDA CBR 900	02	03	
	HONDA Hornet 600	03	08	
	HONDA Hornet 900	02	08	
	HONDA CB 1000 R	08		
	TRIUMPH STREET TRIPLE 675	07	08	
	TRIUMPH DAYTONA 675	07	08	

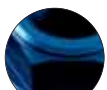
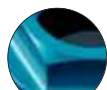

D007



Perno forcellone
swing arm pivot shaft

MODELLO model
HONDA Hornet 600

ANNO year	PASSO pitch	
	DAL from	AL to
03 08	14 x 1,5	

D010



Perno forcellone
swing arm pivot shaft

ANNO year	PASSO pitch	
	DAL from	AL to
03 08	20 x 1,5	
04 08		
07 08		
04 08		
05 08		
06 08		
06 08		
07 08		
03 05		
04 05		

D008



Perno ruota posteriore
rear wheel axle

MODELLO model
DUCATI 748
DUCATI 916
DUCATI 996
DUCATI 998
DUCATI DS 1000
DUCATI MONSTER S4R
DUCATI HYPERMOTARD
1100 lato sx/left side

ANNO year	PASSO pitch	
	DAL from	AL to
03 08	M38 x 1,5	
03 04		
07 08		

D011



Perno ruota posteriore
rear wheel axle

MODELLO model
HONDA Hornet 600
SUZUKI SV 650
YAMAHA MT-03

ANNO year	PASSO pitch	
	DAL from	AL to
03 08	16 x 1,5	
99 02		
06 08		

Perno forcellone
swing arm pivot shaft

MODELLO model
YAMAHA MT-03
TRIUMPH STREET TRIPLE 675
TRIUMPH DAYTONA 675

ANNO year	PASSO pitch	
	DAL from	AL to
06 08		
07 08		
07 08		

D009



Perno corona
rear sprocket

MODELLO model
DUCATI 748
DUCATI 916
DUCATI 996
DUCATI 998
DUCATI DS 1000

ANNO year	PASSO pitch	
	DAL from	AL to
03 08	33 x 1,5	

Perno ruota post.
rear wheel axle

MODELLO model
DUCATI HYPERMOTARD 1100
lato dx/right side
DUCATI 1098+848
lato sinisto/left side

ANNO year	PASSO pitch	
	DAL from	AL to
07 08		
07 08		

D013



Canotto sterzo
steering stem head

MODELLO model
SUZUKI GSXR 600/750
SUZUKI GSXR 1000
SUZUKI SV 650
SUZUKI GSR 600

ANNO year	PASSO pitch	
	DAL from	AL to
04 05	24 x 1,5	
02 02		
03 08		
06 08		

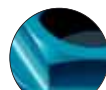

D014



Canotto sterzo
steering stem head

MODELLO
model

KAWASAKI ZX6R
KAWASAKI ZX10R
SUZUKI GSXR 1000
SUZUKI GSXR 600/750
YAMAHA R1
YAMAHA R6
YAMAHA FZ1

ANNO year
DAL from AL to

05	08
04	07
03	08
06	08
04	08
03	08
06	08

PASSO
pitch

28 x 1

D020



Perno ruota posteriore
rear wheel axle

MODELLO
model

DUCATI 1098 + 848
lato dx/right side
TRIUMPH Speed Triple 1050
lato dx/right side

ANNO year
DAL from AL to

07	08
05	08

PASSO
pitch

38 x 1,5

D018



Perno ruota posteriore
rear wheel axle

HONDA CBR 1000
HONDA CBR 600
HONDA CBR 900
SUZUKI GSR 600

04	08
03	08
02	03
06	08

22 x 1,5

Perno forcellone
swing arm pivot shaft

HONDA CBR 1000
YAMAHA R6

04	08
06	08

D021



Perno corona
rear sprocket

TRIUMPH Speed Triple 1050
lato sx/left side

05	08
----	----

35 x 1,5

D019



Perno ruota anteriore
front wheel axle

DUCATI 748
DUCATI 916
DUCATI 996
DUCATI 998
DUCATI DS 1000
DUCATI Monster
Dark 620 IE

03	08
----	----

25 x 1,25

D022



Canotto sterzo
steering stem head

HONDA CBR 1000

08	
----	--

33 x 1

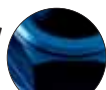
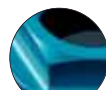

ANDREA DOVIZIOSO

JiR Team Scot



TEAM SAN CARLO HONDA GRESINI CAMPIONATO ITALIANO MINIGP



PEDANA / rear sets
cod. FTR02HMGP08

mozzetti H. 20 handlebar holders H. 20	MOZ4520
leva frizione clutch lever	LEV7100S
protezioni perni ruota wheel axle protections	AR19
protezioni telaio frame protections	PRTHMINIGP
tappo serbatoio fuel tank caps	TF2



TAPPI
CAPS



TAPPI SERBATOIO ATTACCO RAPIDO

fuel tank caps with rapid locking

TAPPI SERBATOIO A VITE

fuel tank caps with screw locking



MODELLO model	ANNO year		CODICE code
	DAL from	AL to	
APRILIA			TR5
APRILIA RSV 1000	04	08	TR8
DUCATI			TR1
GUZZI			TR5
HONDA			TR2
KAWASAKI			TR4
KAWASAKI ZX10 R	06	08	TR9
KAWASAKI 636	07	08	TR9
MV AGUSTA			TR1
SUZUKI			TR3
SUZUKI GSXR 1000	03	08	TR6
SUZUKI GSXR 600/750	04	08	TR6
SUZUKI GSR 600	06	08	TR6
TRIUMPH			TR5
YAMAHA			TR1
RICAMBIO FLANGIA INTERNA INTERNAL SPARE PART			TRF



MODELLO model	ANNO year		CODICE code
	DAL from	AL to	
DUCATI			TF1
HONDA			TF2
KAWASAKI			TF4
KAWASAKI ZX10 R	06	08	TF9
KAWASAKI 636	07	08	TF9
MV AGUSTA			TF1
SUZUKI GSXR 1000	03	08	TF6
SUZUKI GSXR 600/750	04	08	TF6
SUZUKI GSR 600	06	08	TF6
YAMAHA			TF1
RICAMBIO FLANGIA INTERNA INTERNAL SPARE PART			TFC

COLORI DISPONIBILI PER FLANGIA INTERNA
available colours for inside part:

**NERO /
BLACK**



DUCATI 749-999			TR7
DUCATI DS 1000 Multistrada			TR7



CHIAVE RACING TFT
RACING KEY

COLORI DISPONIBILI PER FLANGIA INTERNA
available colours for inside part:

**NERO
BLACK**



**SILVER
SILVER**



COLORI DISPONIBILI PER ESTERNO
available colours for external part:

**NERO
BLACK**



**BLU
BLUE**



**ROSSO
RED**



**ORO
GOLD**



**INDACO
INDIGO**



**SILVER
SILVER**



TAPPO OLIO oil filter plugs

VALVOLA SFIATO BENZINA breathing valve

MODELLO
model

MISURA
measure

CODICE
code

CODICE
code



APRILIA Tuono 1000	M20 x 1,5	OILS
BENELLI	M24 x 1,5	OILB
CAGIVA RAPTOR	M20 x 1,5	OILS
DUCATI	M22 x 1,5	OILD
DUCATI 848	M20 x 2,5	OILH
DUCATI MONSTER 696	M20 x 2,5	OILH
GUZZI Griso	M20 x 1,5	OILS
HONDA X11-XX1100	M23 x 3	OILH2
HONDA	M20 x 2,5	OILH
HUSQUARNA	M17,5 x 1,5	OILHUS
KAWASAKI	M30 x 1,5	OILK2
KAWASAKI ER 6N	M20 x 2,5	OILH
MINARELLI	M14 x 1,5	OILM
MORINI CORSARO	M24 x 1,5	OILB
MV AGUSTA	M25 x 1,5	OILMV
SUZUKI	M20 x 1,5	OILS
TRIUMPH	M20 x 2,5	OILH
YAMAHA	M26 x 3	OILY
YAMAHA XJR	M27 x 1,5	OILY2
YAMAHA MT-03	M20 x 2,5	OILH
YAMAHA T-Max	M20 x 2,5	OILH



W

APRILIA Tuono 1000	M20 x 1,5	OILSW
CAGIVA RAPTOR	M20 x 1,5	OILSW
DUCATI	M22 x 1,5	OILDW
DUCATI 848	M20 x 2,5	OILHW
DUCATI MONSTER 696	M20 x 2,5	OILHW
GUZZI Griso	M20 x 1,5	OILSW
HONDA	M20 x 2,5	OILHW
KAWASAKI	M30 x 1,5	OILK2W
KAWASAKI ER 6N	M20 x 2,5	OILHW
SUZUKI	M20 x 1,5	OILSW
TRIUMPH	M20 x 2,5	OILHW
YAMAHA	M26 x 3	OILYW
YAMAHA MT-03	M20 x 2,5	OILHW
YAMAHA T-Max	M20 x 2,5	OILHW



W



VALB09

Colori disponibili: oro, nero.
Available colours: gold, black.

SFIATO OLIO MOTORE DUCATI engine oil breather for DUCATI



SFI2



MODELLO model	ANNO year		CODICE code
	DAL from	AL to	
DUCATI			
DUCATI 696	08	FRENO ANT / front brake	FBC07
		FRENO POST/ rear brake	FFC03
		FRIZIONE / clutch	FFC04
DUCATI HYPERMOTARD	07 08	FRENO ANT / front brake	FBC04
		FRENO POST/ rear brake	FFC03
		FRIZIONE / clutch	FFC03
DUCATI 848	08	FRENO ANT / front brake	FBC04
		FRENO POST/ rear brake	FFC03
		FRIZIONE / clutch	FFC03
DUCATI 749-999	02 06	FRENO ANT / front brake	FBC08
		FRIZIONE / clutch	FFC02
DUCATI 1098	07 08	FRENO ANT / front brake	FBC04
		FRENO POST/ rear brake	FFC03
		FRIZIONE / clutch	FFC03
KAWASAKI			
KAWASAKI ZX6R	07 08	FRENO ANT / front brake	FBC06
		FRENO POST/ rear brake	FFC05
KAWASAKI Z750/Z1000	03 06	FRENO ANT / front brake	FBC02
KAWASAKI Z750/Z1000	07 08	FRENO ANT / front brake	FBC06
		FRENO POST/ rear brake	FFC05
KAWASAKI ZX10R	08	FRENO ANT / front brake	FBC06
		FRENO POST/ rear brake	FFC05
KAWASAKI ER-6N	06 08	FRENO ANT / front brake	FBC02
KTM			
KTM RC8 1190	08	FRENO ANT / front brake	FBC06
KTM 990 SUPER DUKE	07 08	FRENO ANT / front brake	FBC04
		FRENO POST/ rear brake	FFC03
KTM 690		FRENO ANT / front brake	FFC04
		FRENO POST/ rear brake	FFC03
HONDA			
HONDA CBR 1000	04 05	FRENO ANT / front brake	FBC14
HONDA CBR 1000	06 07	FRENO ANT / front brake	FBC06
HONDA CBR 1000	08	FRENO ANT / front brake	FBC06
		FRENO POST/ rear brake	FFC05
HONDA CBR 600	03 06	FRENO ANT / front brake	FBC01
HONDA CBR 600	07 08	FRENO ANT / front brake	FBC06
HONDA HORNET 600	03 06	FRENO ANT / front brake	FBC01
HONDA CB 1000	08	FRENO ANT / front brake	FBC06
		FRENO POST/ rear brake	FBC06
		FRIZIONE / clutch	FFC05
HONDA HORNET 900	02 07	FRENO ANT / front brake	FBC01



Colori disponibili per tutti i coperchi:
oro, blu, rosso, silver, nero.
Available colours for all covers: gold, blue,
red, silver, black.

MODELLO model	ANNO year		CODICE code
	DAL from	AL to	
MV			
MV AGUSTA F4	00 08	FRENO ANT / front brake	FBC03
		FRIZIONE / clutch	FFC01
MV AGUSTA BRUTALE	05 08	FRENO ANT / front brake	FBC03
		FRIZIONE / clutch	FFC01
SUZUKI			
SUZUKI GSXR 600/750	04 08	FRENO ANT / front brake	FBC06
SUZUKI GSXR 1000	05 06	FRENO ANT / front brake	FBC06
SUZUKI GSXR 1000	07 08	FRENO ANT / front brake	FBC06
		FRENO POST/ rear brake	FFC05
SUZUKI GSR 600	06 08	FRENO ANT / front brake	FBC13
TRIUMPH			
DAYTONA 675	07 08	FRENO ANT / front brake	FBC06
		FRENO POST/ rear brake	FFC05
STREET TRIPLE 675		FRENO ANT / front brake	FBC02
		FRENO POST/ rear brake	FFC05
YAMAHA			
YAMAHA FAZER 1000	01 05	FRENO ANT / front brake	FBC02
YAMAHA FZ1	06 08	FRENO ANT / front brake	FBC11
YAMAHA FZ6	04 06	FRENO ANT / front brake	FBC11
YAMAHA MT 03	06 08	FRENO ANT / front brake	FBC11
		FRENO POST/ rear brake	FFC05
YAMAHA T-MAX	04 08	FRENO ANT / front brake	FBC15
		FRENO POST/ rear brake	FBC15
YAMAHA R6	03 05	FRENO ANT / front brake	FBC06
YAMAHA R6	06 08	FRENO ANT / front brake	FBC06
		FRENO POST/ rear brake	FFC05
YAMAHA R1	04 08	FRENO ANT / front brake	FBC06



Colori disponibili per tutti i coperchi:
oro, blu, rosso, silver, nero.
Available colours for all covers: gold, blue, red, silver, black.

REGOLATORI MOLLA
fork spring adjusters



SILVER / SILVER



INDACO / INDIGO



ROSSO / RED



BLU / BLUE



NERO / BLACK



ORO / GOLD



MODELLO
model

ANNO year

CODICE
code

a coppia
/for pair

YAMAHA R1 REGOLAZIONE IDRAULICA/HYDRAULIC REGULATION
KAWASAKI ZX10R REGOLAZIONE IDRAULICA/HYDRAULIC REGULATION

DAL
from

AL
to

REGR1
REGR1

HONDA
SUZUKI GSXR 600

04 05
01 03

REGH
REGS6

ESAGONO CH14
ESAGONO CH17
ESAGONO CH19
ESAGONO CH22

REGCH14
REGCH17
REGCH19
REGCH22



SERBATOIO
RIFORMIMENTO

FUEL CANISTER

	CODICE code	COLORE SERBATOIO fuel canister colour	COLORE ACCESSORI accessories colour
5 LITRI / LITRES	SER01	nero / black bianco / white	blu / indigo nero / black rosso / red oro / gold
10 LITRI / LITRES	SER02	nero / black bianco / white	blu / indigo nero / black rosso / red oro / gold
20 LITRI / LITRES	SER03	nero / black bianco / white	blu / indigo nero / black rosso / red oro / gold

	CODICE code	COLORE SERBATOIO fuel canister colour	COLORE ACCESSORI accessories colour
5 LITRI / LITRES	SER04	nero / black bianco / white	blu / indigo nero / black rosso / red oro / gold
10 LITRI / LITRES	SER05	nero / black bianco / white	blu / indigo nero / black rosso / red oro / gold
20 LITRI / LITRES	SER06	nero / black bianco / white	blu / indigo nero / black rosso / red oro / gold



5 LITRI / LITRES



10 LITRI / LITRES



20 LITRI / LITRES



TEAM ASPAR MARTINEZ

125 GP
250GP



SPECCHIETTI
MIRRORS



TEAM MERSON





BLU / BLUE

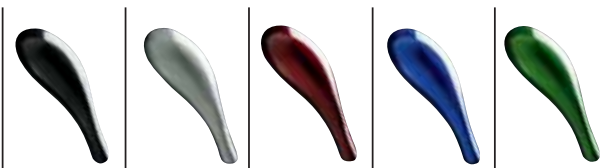

	CARBONIO CARBON	ALLUMINIO ALUMINIUM	ROSSO RED	BLU BLUE	VERDE GREEN
	COD. code	COD. code	COD. code	COD. code	COD. code
	a coppia /for pair	a coppia /for pair	a coppia /for pair	a coppia /for pair	a coppia /for pair
Base piccola (interasse da 27,5 a 39 mm) Small adaptor (int. from 27,5 to 39 mm)	SPEC4	SPEA4	SPEEV04ROS	SPEEV04BLU	SPEEV04VER
Base grande (interasse da 54,5 a 69,5 mm) Big adaptor (int. from 54,5 to 69,5 mm)	SPEC2	SPEA2	SPEEV02ROS	SPEEV02BLU	SPEEV02VER
Base DUCATI 748/916/996/998 Adaptor DUCATI 748/916/996/998	SPEC3	SPEA3	SPEEV03ROS	SPEEV03BLU	SPEEV03VER



SPEY05 a coppia/for pair
ADATTATORE SPECCHI R6/2008
mirrors adaptor R6/2008

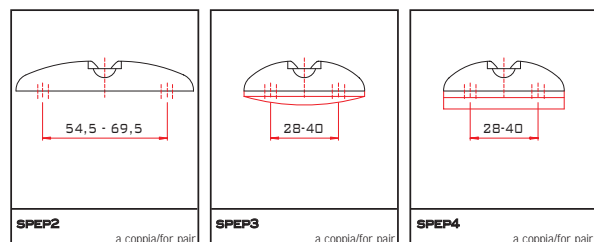

SPEP2 a coppia/for pair
SPEP3 a coppia/for pair
SPEP4 a coppia/for pair



ARTICOLO
article

CODICE
code

a coppia
/for pair

PROMO

OVALE PICCOLO/ LITTLE OVAL
Coppia specchi: 2 gambi M10 x 1,25 dx
Mirrors couple: 2 supports M10 x 1,25 right

NERO/BLACK ----> SPEAL010NER
SILVER/SILVER ----> SPEAL010SIL

YAMAHA
Coppia specchi: 1 gambo M10 x 1,25 dx + 1 sx
Mirrors couple: 1 support M10 x 1,25 right + 1 left

NERO/BLACK ----> SPEAL010WNER
SILVER/SILVER ----> SPEAL010WSIL



PROMO

OVALE GRANDE/ BIG OVAL
Coppia specchi: 2 gambi M10 x 1,25 dx
Mirrors couple: 2 supports M10 x 1,25 right

NERO/BLACK ----> SPEAL011NER
SILVER/SILVER ----> SPEAL011SIL

YAMAHA
Coppia specchi: 1 gambo M10 x 1,25 dx + 1 sx
Mirrors couple: 1 support M10 x 1,25 right + 1 left

NERO/BLACK ----> SPEAL011WNER
SILVER/SILVER ----> SPEAL011WSIL



RETTANGOLAR / RECTANGULAR
Coppia specchi: 2 gambi M10 x 1,25 dx
Mirrors couple: 2 supports M10 x 1,25 right

NERO/BLACK ----> SPEAL012NER
SILVER/SILVER ----> SPEAL012SIL

YAMAHA
Coppia specchi: 1 gambo M10 x 1,25 dx + 1 sx
Mirrors couple: 1 support M10 x 1,25 right + 1 left

NERO/BLACK ----> SPEAL012WNER
SILVER/SILVER ----> SPEAL012WSIL

TAPPO SPECCHIO YAMAHA T-MAX
mirror cover Yamaha T-Max



ADATTATORE SPECCHIO
mirror adaptor



	ANNO year		CODICE code	a coppia /for pair
	DAL from	AL to		
T-MAX	03	07	SPEY01	
T-MAX	08		SPEY03	

Colori: nero.
Colours: black.

TAPPO SPECCHIO
mirror cover



T-MAX	03	07	SPEY02	
T-MAX	08		SPEY04	

Colori: blu, oro, nero, rosso.
Colours: blue, gold, black, red.

PROTEZIONI
PROTECTIONS

Per proteggere il vostro telaio, ci siamo ispirati alla morbidezza.



GUSCIO IN MAGNESIO
La lega più morbida ed elastica, ideale per il perfetto rapporto peso/robustezza.

BOCOLA PER OSCILLAZIONE
Permette un gioco assiale di oltre 10° tra i vari componenti.

GOMMINO ANTISHOCK
Il vero cuore del sistema brevettato, realizzato in gomma termoplastica TPE durezza 60 SHORE.

Dall'esperienza in pista, è nata l'evoluzione nella protezione telaio.

Dagli sviluppi e i test in Superbike e SuperSport, LightTech ha realizzato una nuova protezione che riduce notevolmente i rischi di rottura del telaio grazie alla tecnologia Shock Absorber® brevettata. Una tecnologia dal cuore morbido, nata in pista, pensata per te.

MODELLO model	ANNO year		M	Ø	CODICE code	a coppia /for pair
	DAL from	AL to				
DUCATI						
DUCATI HYPERMOTARD	07	08	NO	10	PRTDHYPER	
DUCATI MONSTER 696	08		NO	10	PRT08D001	
HONDA						
HONDA CBR 600 RR	03	06	DX / SX	12	PRT1250	
HONDA CBR 600 RR	07	08	NO	10	PRTHCBR607	
HONDA CBR 900	00	03	NO	10	PRT2250	
HONDA HORNET 600	03	06	NO	10	PRT1251	
HONDA HORNET 600	07	08	NO	12	PRTHH607	
HONDA HORNET 900	02	06	NO	10	PRT1252	
HONDA CBR 1000	04	05	NO	10	PRT3251	
HONDA CBR 1000	06	07	NO	10	PRTCBR106	
HONDA CBR 1000	08		DX / SX	12	PRTCBR108	
HONDA CBF 1000	06	07	NO	12	PRTCBF106	
HONDA CB 1000	08		NO	12	PRT08H001	
HONDA VFR 800	02	06	NO	10	PRTVFR800	
KAWASAKI						
KAWASAKI ZX6R	03	04	NO	10	PRT1350	
KAWASAKI ZX6R	05	06	DX / SX	10	PRT1352	
KAWASAKI ZX6R	07	08	NO	10	PRTKZX6R07	
KAWASAKI ZX10R	04	05	DX / SX	10	PRT1351	
KAWASAKI ZX10R	08		SX	10	PRTKZX10R08	
KAWASAKI Z750	04	06	NO	10	PRTKZ1000	
KAWASAKI Z1000	03	06	NO	10	PRTKZ1000	
KAWASAKI Z750	07	08	NO	10	PRTKZ7507	
KAWASAKI Z1000	07	08	NO	10	PRTKZ7507	
KAWASAKI ER-6N	06	08	NO	10	PRT1112	
KTM						
KTM SUPER DUKE	05	06	NO	10	PRT3570	
KTM SUPER DUKE 990	07	08	NO	10	PRTKSD07	
MV						
MV BRUTALE 750/1000			NO	13	PRT3560	

Colori: nero / Colours: black

M = FORARE CARENA / DRILL FAIRING
DX = destro / right - SX = sinistra / left
Ø = foro interno boccola / internal bush hole

MODELLO model	ANNO year		M	Ø	CODICE code	a coppia /for pair
	DAL from	AL to				
SUZUKI						
SUZUKI GSXR 600	01	03	SX	10	PRT1450	
SUZUKI GSXR 750	00	03	SX	10	PRT1450	
SUZUKI GSXR 600/750	04	05	NO	10	PRT1451	
SUZUKI GSXR 600/750	06	07	NO	10	PRTGSXR606	
SUZUKI GSXR 600/750	08		SX	10	PRTGSXR608	
SUZUKI GSXR 600/750	08		NO	10	PRT08S001	
SUZUKI GSXR 1000	01	02	SX	10	PRT2450	
SUZUKI GSXR 1000	03	04	NO	10	PRT2451	
SUZUKI GSXR 1000	05	06	NO	10	PRT1453	
SUZUKI GSXR 1000	07	08	NO	10	PRTGSXR1007	
SUZUKI SV 650/S/1000	99	03	NO	10	PRTSV650	
SUZUKI SV 650/S/1000	04	08	NO	10	STESU001	
SUZUKI GSR 600	06	08	NO	10	PRT1108	
TRIUMPH						
TRIUMPH Speed Triple 1050	05	07	NO	12	PRT3580	
TRIUMPH Speed Triple 1050	08		NO	12	PRT08T001	
TRIUMPH Street Triple 675	07	08	NO	10	PRTTST607	
YAMAHA						
YAMAHA R1	02	03	NO	10	PRT1550	
YAMAHA R1	04	06	NO	10	PRT1552	
YAMAHA R1	07	08	NO	10	PRTYR107	
YAMAHA R6	99	02	DX / SX	12	PRT2550	
YAMAHA R6	03	05	SX	10	PRT2551	
YAMAHA R6	06	07	NO	10	PRT1104	
YAMAHA R6	08		NO	10	PRTYR608	
YAMAHA FAZER 600 + FZ6	04	08	NO	10	PRT3550	
YAMAHA FZ1	06	08	NO	10	PRTYF1006	
YAMAHA MT-03	06	08	NO	10	PRTYMT0306	

Colori: nero / Colours: black

M = FORARE CARENA / DRILL FAIRING
DX = destro / right - SX = sinistra / left
Ø = foro interno boccola / internal bush hole



RICAMBI PROTEZIONE TELAIO
FRAME PROTECTION SPARE PARTS

PROTEZIONE CARTER MOTORE
ENGINE COVER PROTECTION



MODELLO model	ANNO year		CODICE code
	DAL from	AL to	
YAMAHA R6 (M18) - DX	03	05	PRT3600
YAMAHA R6 (M22) - SX	06	07	PRT3610
YAMAHA R1 - DX	04	06	PRT3600
YAMAHA R1 (M30x1) - DX	07	08	PRT3620
YAMAHA R1 (M20) -SX	07	08	PRT3630

DX = destro / right
SX = sinistra / left

PROTEZIONE CARTER MOTORE
ENGINE COVER PROTECTION



KAWASAKI Z 1000	03	06	PRT1360
-----------------	----	----	---------

RICAMBI PROTEZIONE TELAIO
FRAME PROTECTION SPARE PARTS

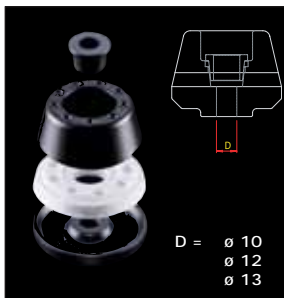

BOCCOLE Ø10 / BUSHES Ø10			PRTRIC10
BOCCOLE Ø12 / BUSHES Ø12			PRTRIC12
BOCCOLE Ø13 / BUSHES Ø13			PRTRIC13



HONDA CBR 1000	04	05	PRTRICH04
----------------	----	----	-----------

Colori: nero.
Colours: black.

a pezzo
/for piece



MODELLO model	ANNO year		Ø	Ø	Ø	Ø	CODICE code
	DAL from	AL to	ANT. DX RIGHT FRONT	ANT. SX LEFT FRONT	POST. DX RIGHT REAR	POST. SX LEFT REAR	
KAWASAKI ZX6R	07	08	22	22	19,5	14,5	ARK607
KAWASAKI ZX10R	06	07	19,3	15,6	14,6	10,6	ARK107
KAWASAKI ZX10R	08		22	22	14	10	ARK108
HONDA CBR 600 R	07	08	M14 x 1,50	17	14	19,6	ARH607
HONDA CBR 1000 R	08		M18 x 1,50	22	14	19,3	ARH108
SUZUKI GSXR 600/750	06	08	M18x1,50	24	16,5	23,2	ARS07
SUZUKI GSXR 1000	07	08	M18x1,50	24	16,5	23,2	ARS07
YAMAHA R6	06	08	19	M14 x 1,5	16	23,5	ARY107
YAMAHA R1	07	08	19	M14 x 1,5	16	23,5	ARY107

DISTANZIALE PERNO RUOTA PER T-MAX
T-Max wheel axle spacer



DPRYA001

Colori: rosso, indaco, oro, nero.
Colours: red, indigo, gold, black.



TEAM ALSTARE SUZUKI:
MAX NEUKIRCHNER, YUKIO KAGAYAMA

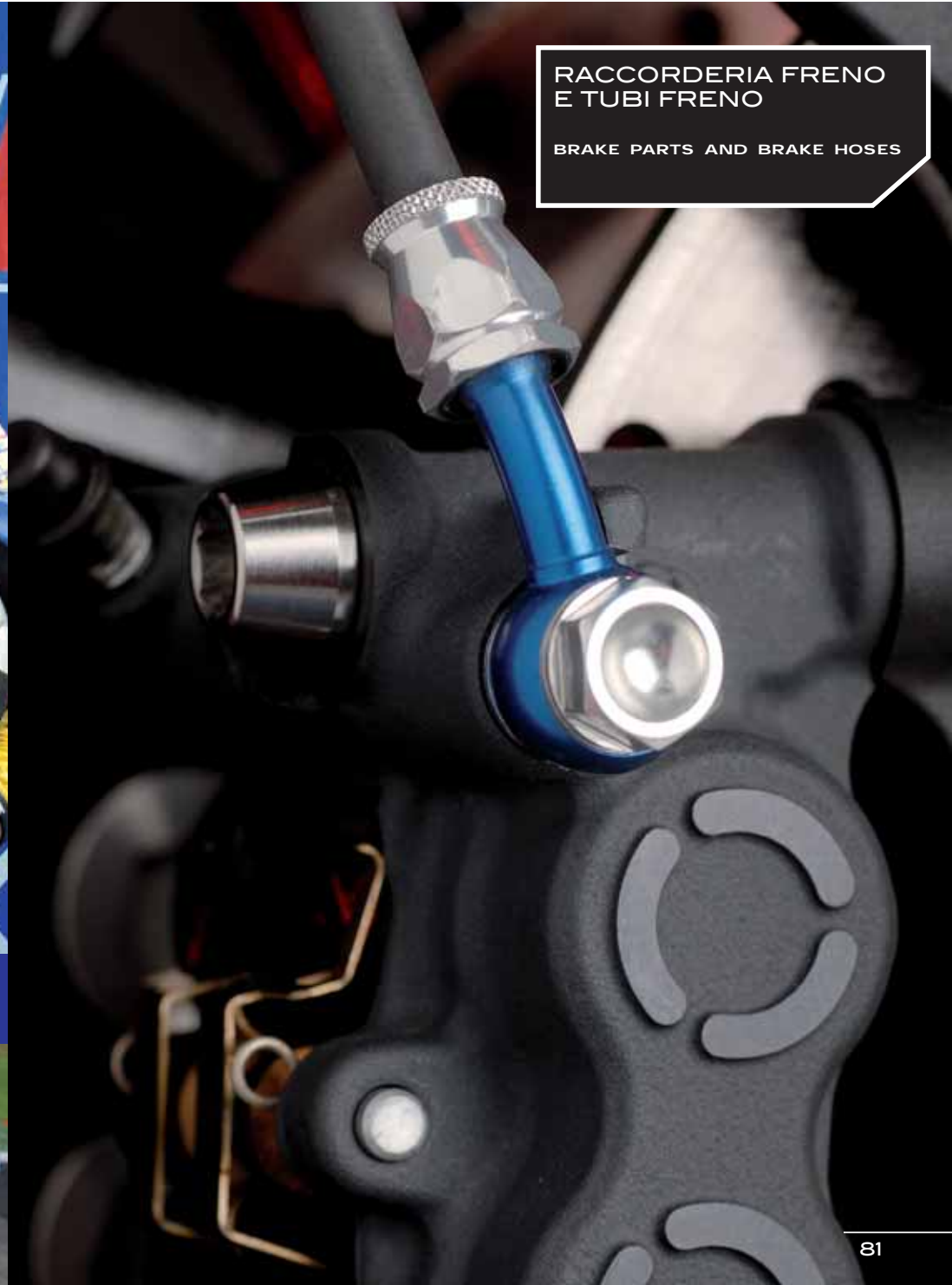

RACCORDERIA FRENO
E TUBI FRENO
BRAKE PARTS AND BRAKE HOSES

ARTICOLO
article

MISURA
measure

CODICE
code

ARTICOLO
article

CODICE
code



BULLONE SINGOLO
SINGLE BOLT

M10 x 1 VF11
M10 X 1,25 VF1251



OGIVA OTTONE
BRASS HOSE HOLDER

OG



BULLONE DOPPIO
DOUBLE BOLT

M10 x 1 VF12
M10 X 1,25 VF1252



RACCORDO TRE VIE
completo di ogive e dadi

RAC3

THREE-WAY JOINT SET
with hose holders and nuts



**BULLONE SINGOLO
CON SPURGO**

M10 x 1 VF11SP
M10 X 1,25 VF1251SP

SINGLE BOLT
WITH BLEEDER

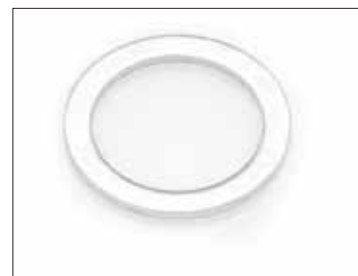

RONDELLE ALLUMINIO
ALU WASHERS

RONA



**BULLONE DOPPIO
CON SPURGO**

M10 x 1 VF12SP
M10 X 1,25 VF1252SP

DOUBLE BOLT
WITH BLEEDER



**TUBO TEFLON MAGLIA
D'ACCIAIO**

TUBT

TEFLON HOSE STEEL
COVERED

ARTICOLO
article

MISURA
measure

CODICE
code

ARTICOLO
article

CODICE
code



SPURGO
BLEEDER

M6	SPM6
M7	SPM7
M8	SPM8
M10 x 1	SPM10



OCCHIELLO DRITTO CON DADO
BANJO FITTING SET

OCD



DADO PER OCCHIELLI
BANJO NUT

DAD



OCCHIELLO 25° CON DADO
25° ELBOW BANJO FITTING SET

OC25



GUAINA TERMORETRAIBILE
Disponibile nei colori:
blu, rosso, giallo, trasparente, nero

GUAINA

THERMOSHRINKING
Available colours:
blue, red, gold, black, transparent

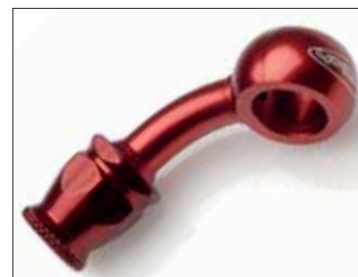

OCCHIELLO 45° CON DADO
45° ELBOW BANJO FITTING SET

OC45



SPIRALINA NERA
BLACK-SPIRAL
THERMOSHRINKING

SPI



OCCHIELLO 90° CON DADO
90° ELBOW BANJO FITTING SET

OC90



DISTRIBUTORI ESCLUSIVI PER L'ITALIA / DISTRIBUTORS FOR ITALY

Il prezzo viene calcolato prendendo gli ultimi due dati del codice e facendo riferimento alla tabella qui sotto riportata (disponibili in vari colori):
The price has been calculated taking the last two letters of the code as you see in the below table (available in various colours):

- MCH...H1 =
- MCH...V1 =
- MCH...V2 =
- MCH...V3 =
- MCH...V4 =
- MCH...V6 =

MODELLO model	ANNO year		CODICE ANT. code front	CODICE POST. code rear
	DAL from	AL to		
APRILIA				
APRILIA RSV Mille	01			MCH 806 H1
HONDA				
HONDA Hornet 600	03	06	MCH 197 V2	MCH 197 H1
HONDA CBR 600 RR	03	04	MCH 198 V2	MCH 198 H1
HONDA CBR 600 RR	05	06	MCH 817 V2	MCH 198 H1
HONDA CBR 600 RR	07	08	MCH 829 V2	MCH 829 H1
HONDA CBR 900	02	03	MCH 195 V2	MCH 195 H1
HONDA CBR 1000 RR	04	05	MCH 108 V2	MCH 108 H1
HONDA CBR 1000 RR	06	07	MCH 108 V2	MCH 388 H1
HONDA CBR 1000 RR	08		MCH 840 V2	MCH 840 H1
HONDA VTR SP2	04	06	MCH 194 V2	MCH 194 H1
KAWASAKI				
KAWASAKI ZX-6R	03	04	MCH 388 V2	MCH 388 H1
KAWASAKI ZX-6R	05	06	MCH 396 V2	MCH 193 H1
KAWASAKI ZX-6R	07	08	MCH 839 V2	MCH 116 H1
KAWASAKI ER-6 N	05	06	MCH 398 V2	MCH 398 H1
KAWASAKI Z750	04	07	MCH 392 V2	MCH 389 H1
KAWASAKI Z1000	03	06	MCH 389 V2	MCH 389 H1
KAWASAKI ZX10 R	04	05	MCH 393 V2	MCH 185 H1
KAWASAKI ZX10 R Ninja	06	07	MCH 399 V2	MCH 438 H1
SUZUKI				
SUZUKI GSXR 600	04	05	MCH 296 V2	MCH 353 H1
SUZUKI GSXR 600	06	08	MCH 821 V2	MCH 821 H1
SUZUKI GSR 600	06	07	MCH 822 V2	MCH 334 H1
SUZUKI SV 650	03	05	MCH 294 V2	MCH 101 H1
SUZUKI SV 650 S	03	05	MCH 293 V2	MCH 293 H1
SUZUKI GSXR 750	00	03	MCH 282 V2	MCH 240 H1
SUZUKI GSXR 750	04	05	MCH 296 V2	MCH 353 H1
SUZUKI GSXR 750	06	07	MCH 821 V2	MCH 821 H1
SUZUKI GSXR 1000	01	02	MCH 285 V2	MCH 206 H1
SUZUKI GSXR 1000	03	04	MCH 290 V2	MCH 290 H1
SUZUKI GSXR 1000	05	06	MCH 299 V2	MCH 206 H1
SUZUKI GSXR 1000	07	08	MCH 299 V2	MCH 299 H1
YAMAHA				
YAMAHA YZF R6	03	04	MCH 488 V2	MCH 488 H1
YAMAHA YZF R6	05	05	MCH 489 V2	MCH 488 H1
YAMAHA YZF R6	06	08	MCH 493 V2	MCH 493 H1
YAMAHA FZ6 Fazer	04	06	MCH 490 V2	MCH 490 H1
YAMAHA MT-03	06	07	MCH 494 V2	MCH 494 H1
YAMAHA TDM	02		MCH 486 V2	MCH 486 H1
YAMAHA YZF R1	02	03	MCH 477 V2	MCH 352 H1
YAMAHA YZF R1	04	06	MCH 489 V2	MCH 489 H1
YAMAHA YZF R1	07	08	MCH 496 V2	MCH 496 H1
YAMAHA FZ1	06	07	MCH 495 V2	MCH 495 H1
YAMAHA FZ1 Fazer	01	05	MCH 495 V2	MCH 495 H1



CAVALLETTI
STANDS



ARTICOLO
article

CODICE
code



Coppia cavalletti SFILABILI H 350 RSA11
in **ALLUMINIO**

PAIR OF ALUMINIUM EXTENSIBLE
STANDS H 350



Coppia cavalletti SFILABILI H 570 RSA12
in **ALLUMINIO**

PAIR OF ALUMINIUM EXTENSIBLE
STANDS H 570



CAVALLETTO ANTERIORE CENTRALE RSA15
in **ALLUMINIO**

ALUMINIUM FRONT TRIPLE TREE LIFT

ARTICOLO
article

CODICE
code



CAVALLETTO ANTERIORE IN FERRO RSF18
FRONT STAND IN IRON



CAVALLETTO POSTERIORE IN FERRO RSF19
CON FORCHETTE
REAR STAND IN IRON WITH FORKS

CAVALLETTO POSTERIORE IN FERRO RSF19P
CON PATTINI
REAR STAND IN IRON WITH SLIDING BLOCKS

CAVALLETTO POSTERIORE IN FERRO RSF19R
CON RULLI
REAR STAND IN IRON WITH ROLLERS



SEGGIOLINO OFFICINA IN FERRO RSF20
IRON WORKSHOP STOOL

ARTICOLO
article

CODICE
code



**CAVALLETTO ANTERIORE IN FERRO
CON RUOTE A CUSCINETTI** RSF22

IRON FRONT STAND WITH WHEELS
AND BEARINGS



FORCHETTE / FORKS
cod. RSF23

a coppia /for pair



PATTINI / SLIDING BLOCKS
cod. RSF24

a coppia /for pair



RULLI / ROLLERS
cod. RSF25

a coppia /for pair

ARTICOLO
article

CODICE
code



**CAVALLETTO POSTERIORE IN
FERRO CON RUOTE A CUSCINETTI
CON FORCHETTE** RSF21

IRON REAR STAND WITH WHEELS AND
BEARINGS AND FORKS

**CAVALLETTO POSTERIORE IN
FERRO CON RUOTE A CUSCINETTI
CON PATTINI** RSF21P

IRON REAR STAND WITH WHEELS AND
BEARINGS AND SLIDING BLOCKS

**CAVALLETTO POSTERIORE IN
FERRO CON RUOTE A CUSCINETTI
CON RULLI** RSF21R

IRON REAR STAND WITH WHEELS AND
BEARINGS AND ROLLERS



RSF21



RSF21P



RSF21R



**CARRELLO PORTA CERCHI
in ALLUMINIO** RSA13

ALUMINIUM RIMS CARRIER



CARRELLO PIT LINE in ALLUMINIO RSA17

ALUMINIUM PIT LINE TROLLEY

CAVALLETTO POSTERIORE MONOBRACCIO IN FERRO

ONE ARMED REAR STAND IN IRON



MOTO
bike

Ø

CODICE
code

DUCATI 1098 - 848	40,6	RSF004
HONDA CB 1000 R	28,4	RSF002
HONDA VFR 800	28,4	RSF002
MV BRUTALE	42,7	RSF001
MV F4	42,7	RSF001
TRIUMPH	26,8	RSF003



**RASTRELLIERA PORTA CERCHI
in ALLUMINIO
CON 10 POSTAZIONI** RSA14

ALUMINIUM RIMS RACK
WITH 10 POSITIONS



KIT VITI
SCREWS KIT



MODELLO model	ANNO year		QUANTITA' pieces	CODICE code
	DAL from	AL to		
APRILIA				
RSV 1000				
MOTORE/ENGINE	01	03	55	1A1 M
TELAIO/FRAME			40	1A1 T
CARENA/FAIRING			58	1A1 C
GANCI RAPIDI/QUICK FAIRING FASTENERS			12	1A1 GR
RSV 1000				
MOTORE/ENGINE	04	04	55	4A1 M
TELAIO/FRAME			33	4A1 T
CARENA/FAIRING			57	4A1 C
GANCI RAPIDI/QUICK FAIRING FASTENERS			10	4A1 GR
RSV 1000				
MOTORE/ENGINE	05	08	56	5A1 M
TELAIO/FRAME			33	5A1 T
CARENA/FAIRING			67	5A1 C
GANCI RAPIDI/QUICK FAIRING FASTENERS			10	5A1 GR
TUONO				
MOTORE/ENGINE	03	05	31	3A1 M
TELAIO/FRAME			30	3A1 T
CARENA/FAIRING			73	3A1 C
BENELLI				
TNT				
MOTORE/ENGINE	04		26	4B1 M
TELAIO/FRAME			33	4B1 T
CARENA/FAIRING			43	4B1 C
DUCATI				
MONSTER 900				
MOTORE/ENGINE	99	01	68	KD9 M
TELAIO/FRAME			47	KD9 T
CARENA/FAIRING			26	KD9 C
PEDANE/FOOTRESTS			8	KD9 P
MONSTER 600 / 750				
MOTORE/ENGINE	99	01	53	KD699 M
TELAIO/FRAME			43	KD699 T
CARENA/FAIRING			26	KD699 C
PEDANE/FOOTRESTS			8	KD699 P
DUCATI MONSTER DARK IE 620				
MOTORE/ENGINE	02		54	3DD M
TELAIO/FRAME			48	3DD T
CARENA/FAIRING			25	3DD C
DUCATI MONSTER 696				
MOTORE/ENGINE	08		42	8D6 M
TELAIO/FRAME			14	8D6 T
CARENA/FAIRING			47	8D6 C

MODELLO model	ANNO year		QUANTITA' pieces	CODICE code
	DAL from	AL to		
DUCATI				
DUCATI MONSTER S4				
MOTORE/ENGINE	01	02	75	1DS M
TELAIO/FRAME			26	1DS T
CARENA/FAIRING			48	1DS C
PEDANE/FOOTRESTS			8	1DS P
DUCATI MONSTER S4R				
MOTORE/ENGINE	03	04	65	3DS M
TELAIO/FRAME			35	3DS T
CARENA/FAIRING			48	3DS C
DUCATI 748-916-996				
MOTORE/ENGINE	01		81	KD7 M
TELAIO/FRAME			93	KD7 T
CARENA/FAIRING			29	KD7 C
GANCI RAPIDI/QUICK FAIRING FASTENERS			10	KD7 GR
DUCATI 749-999				
MOTORE/ENGINE	02	06	48	2D9 M
TELAIO/FRAME			33	2D9 T
CARENA/FAIRING			55	2D9 C
GANCI RAPIDI/QUICK FAIRING FASTENERS			9	2D9 GR
DUCATI DS 1000 MULTISTRADA				
MOTORE/ENGINE	03	08	57	3D1 M
TELAIO/FRAME			25	3D1 T
CARENA/FAIRING			51	3D1 C
DUCATI 1098				
MOTORE/ENGINE	07	08	26	7D1 M
TELAIO/FRAME			20	7D1 T
CARENA/FAIRING			73	7D1 C
DUCATI 848				
MOTORE/ENGINE	08		24	8D8 M
TELAIO/FRAME			16	8D8 T
CARENA/FAIRING			77	8D8 C
DUCATI HYPERMOTARD 1100				
MOTORE/ENGINE	07	08	34	7DM M
TELAIO/FRAME			24	7DM T
CARENA/FAIRING			31	7DM C
HONDA				
HONDA HORNET 600				
MOTORE/ENGINE	03	06	41	2H6 M
TELAIO/FRAME			30	2H6 T
CARENA/FAIRING			45	2H6 C
HONDA HORNET 600				
MOTORE/ENGINE	07	08	26	7HH M
TELAIO/FRAME			27	7HH T
CARENA/FAIRING			34	7HH C

MODELLO model	ANNO year		QUANTITA' pieces	CODICE code
	DAL from	AL to		
HONDA				
HONDA HORNET 900				
MOTORE/ENGINE	02	06	40	2HH M
TELAIO/FRAME			34	2HH T
CARENA/FAIRING			45	2HH C
HONDA CBR 600 F				
MOTORE/ENGINE	01	02	27	1HF M
TELAIO/FRAME			34	1HF T
CARENA/FAIRING			59	1HF C
HONDA CBR 600 SPORT				
MOTORE/ENGINE	01	02	27	1HS M
TELAIO/FRAME			34	1HS T
CARENA/FAIRING			61	1HS C
HONDA CBR 600 RR				
MOTORE/ENGINE	03	04	35	3H6 M
TELAIO/FRAME			23	3H6 T
CARENA/FAIRING			58	3H6 C
HONDA CBR 600 RR				
MOTORE/ENGINE	05	06	35	5H6 M
TELAIO/FRAME			25	5H6 T
CARENA/FAIRING			59	5H6 C
HONDA CBR 600 RR				
MOTORE/ENGINE	07	08	25	7H6 M
TELAIO/FRAME			27	7H6 T
CARENA/FAIRING			59	7H6 C
HONDA CBR RR 950				
MOTORE/ENGINE	02	03	23	2H9 M
TELAIO/FRAME			24	2H9 T
CARENA/FAIRING			64	2H9 C
HONDA CBR 1000 RR				
MOTORE/ENGINE	04	05	30	4H1 M
TELAIO/FRAME			24	4H1 T
CARENA/FAIRING			75	4H1 C
HONDA CBR 1000 RR				
MOTORE/ENGINE	06	07	30	6H1 M
TELAIO/FRAME			24	6H1 T
CARENA/FAIRING			68	6H1 C
HONDA CBR 1000 RR				
MOTORE/ENGINE	08		26	8H1 M
TELAIO/FRAME			22	8H1 T
CARENA/FAIRING			43	8H1 C
HONDA CB 1000 R				
MOTORE/ENGINE	08		25	8HB M
TELAIO/FRAME			32	8HB T
CARENA/FAIRING			31	8HB C

MODELLO model	ANNO year		QUANTITA' pieces	CODICE code
	DAL from	AL to		
HONDA				
HONDA CRF 450				
MOTORE/ENGINE		04	37	4H4 M
TELAIO/FRAME			17	4H4 T
CARENA/FAIRING			23	4H4 C
HONDA CRF 450				
MOTORE/ENGINE	05	07	37	5H4 M
TELAIO/FRAME			17	5H4 T
CARENA/FAIRING			25	5H4 C
HONDA CRF 450				
MOTORE/ENGINE	08		37	8H4 M
TELAIO/FRAME			17	8H4 T
CARENA/FAIRING			27	8H4 C
HUSQUARNA				
TE-TC-SMR 250-450-510				
MOTORE/ENGINE	06		24	5Q6 M
TELAIO/FRAME			20	5Q6 T
CARENA/FAIRING			29	5Q6 C
KAWASAKI				
KAWASAKI ZX6R				
MOTORE/ENGINE	03	04	34	3K6 M
TELAIO/FRAME			32	3K6 T
CARENA/FAIRING			65	3K6 C
KAWASAKI ZX6R				
MOTORE/ENGINE	05	06	34	5K6 M
TELAIO/FRAME			32	5K6 T
CARENA/FAIRING			66	5K6 C
KAWASAKI ZX6R				
MOTORE/ENGINE	07	08	37	7K6 M
TELAIO/FRAME			26	7K6 T
CARENA/FAIRING			64	7K6 C
KAWASAKI Z 750				
MOTORE/ENGINE	04	06	32	4K7 M
TELAIO/FRAME			31	4K7 T
CARENA/FAIRING			31	4K7 C
KAWASAKI Z 750				
MOTORE/ENGINE	07	08	32	7K7 M
TELAIO/FRAME			43	7K7 T
CARENA/FAIRING			38	7K7 C
KAWASAKI ZX12 R				
MOTORE/ENGINE	00		25	0K1 M
TELAIO/FRAME			41	0K1 T
CARENA/FAIRING			56	0K1 C

MODELLO model	ANNO year		QUANTITA' pieces	CODICE code
	DAL from	AL to		
KAWASAKI				
KAWASAKI Z1000	03	06		
MOTORE/ENGINE			37	3K1 M
TELAIO/FRAME			33	3K1 T
CARENA/FAIRING			35	3K1 C
KAWASAKI Z1000	07	08		
MOTORE/ENGINE			42	7K1 M
TELAIO/FRAME			50	7K1 T
CARENA/FAIRING			44	7K1 C
KAWASAKI ZX10 R	04	05		
MOTORE/ENGINE			32	4K1 M
TELAIO/FRAME			28	4K1 T
CARENA/FAIRING			58	4K1 C
KAWASAKI ZX10 R	06	07		
MOTORE/ENGINE			36	6K1 M
TELAIO/FRAME			35	6K1 T
CARENA/FAIRING			57	6K1 C
KAWASAKI ZX10 R	08			
MOTORE/ENGINE			26	8K1 M
TELAIO/FRAME			32	8K1 T
CARENA/FAIRING			54	8K1 C
KAWASAKI ER-6N	06	08		
MOTORE/ENGINE			35	6KR M
TELAIO/FRAME			21	6KR T
CARENA/FAIRING			39	6KR C
KTM				
KTM 690	07	08		
MOTORE/ENGINE			28	7M6 M
TELAIO/FRAME			23	7M6 T
CARENA/FAIRING			26	7M6 C
KTM SUPER DUKE 990	07	08		
MOTORE/ENGINE			29	7M9 M
TELAIO/FRAME			30	7M9 T
CARENA/FAIRING			21	7M9 C
KTM RC8 1190	08			
MOTORE/ENGINE			28	8M8 M
TELAIO/FRAME			22	8M8 T
CARENA/FAIRING			44	8M8 C
MOTO GUZZI				
GRISO	05	07		
MOTORE/ENGINE			35	5GG M
TELAIO/FRAME			26	5GG T
CARENA/FAIRING			47	5GG C

MODELLO model	ANNO year		QUANTITA' pieces	CODICE code
	DAL from	AL to		
SUZUKI				
SUZUKI GSXR 600	01	03		
MOTORE/ENGINE			37	1S6 M
TELAIO/FRAME			34	1S6 T
CARENA/FAIRING			68	1S6 C
SUZUKI GSXR 750	00	03		
MOTORE/ENGINE			37	0SR M
TELAIO/FRAME			34	0SR T
CARENA/FAIRING			73	0SR C
SUZUKI GSXR 600/750	04	05		
MOTORE/ENGINE			32	4S6 M
TELAIO/FRAME			36	4S6 T
CARENA/FAIRING			52	4S6 C
SUZUKI GSXR 600/750	06	07		
MOTORE/ENGINE			30	6S6 M
TELAIO/FRAME			28	6S6 T
CARENA/FAIRING			47	6S6 C
SUZUKI GSXR 600/750	08			
MOTORE/ENGINE			33	8S6 M
TELAIO/FRAME			26	8S6 T
CARENA/FAIRING			48	8S6 C
SUZUKI GSXR 1000	01	02		
MOTORE/ENGINE			35	1S1 M
TELAIO/FRAME			34	1S1 T
CARENA/FAIRING			64	1S1 C
SUZUKI GSXR 1000	03	04		
MOTORE/ENGINE			38	3S1 M
TELAIO/FRAME			36	3S1 T
CARENA/FAIRING			52	3S1 C
SUZUKI GSXR 1000	05	06		
MOTORE/ENGINE			38	5S1 M
TELAIO/FRAME			38	5S1 T
CARENA/FAIRING			46	5S1 C
SUZUKI GSXR 1000	07	08		
MOTORE/ENGINE			32	7S1 M
TELAIO/FRAME			39	7S1 T
CARENA/FAIRING			48	7S1 C
SUZUKI GSR 600	06	08		
MOTORE/ENGINE			39	6SR M
TELAIO/FRAME			26	6SR T
CARENA/FAIRING			28	6SR C
TRIUMPH				
TRIUMPH SPEED TRIPLE 955	02	04		
MOTORE/ENGINE			60	2TT M
TELAIO/FRAME			25	2TT T
CARENA/FAIRING			47	2TT C

MODELLO model	ANNO year		QUANTITA' pieces	CODICE code
	DAL from	AL to		
TRIUMPH				
TRIUMPH SPEED TRIPLE 1050	05	07		
MOTORE/ENGINE			57	5TT M
TELAIO/FRAME			25	5TT T
CARENA/FAIRING			44	5TT C
TRIUMPH SPEED TRIPLE 1050	08			
MOTORE/ENGINE			55	8TT M
TELAIO/FRAME			24	8TT T
CARENA/FAIRING			37	8TT C
TRIUMPH DAYTONA 675	07	08		
MOTORE/ENGINE			33	7D6 M
TELAIO/FRAME			34	7D6 T
CARENA/FAIRING			46	7T6 C
TRIUMPH STREET TRIPLE 675	08			
MOTORE/ENGINE			36	7T6 M
TELAIO/FRAME			29	7T6 T
CARENA/FAIRING			33	7T6 C
YAMAHA				
YAMAHA T MAX		03		
MOTORE/ENGINE			20	2YT M
CARENA/FAIRING			37	2YT C
YAMAHA T MAX	04	07		
MOTORE/ENGINE			16	4YT M
CARENA/FAIRING			48	4YT C
YAMAHA T MAX	08			
MOTORE/ENGINE			17	8YT M
CARENA/FAIRING			43	8YT C
YAMAHA FAZER 600 + FZ6 600	04	05		
MOTORE/ENGINE			40	4Y6 M
TELAIO/FRAME			24	4Y6 T
CARENA/FAIRING			38	4Y6 C
YAMAHA FAZER 1000	01	05		
MOTORE/ENGINE			32	1YF M
CARENA/FAIRING			81	1YF C
YAMAHA FZ1	06	08		
MOTORE/ENGINE			35	6Y1 M
TELAIO/FRAME			22	6Y1 T
CARENA/FAIRING			58	6Y1 C
YAMAHA R6	03	04		
MOTORE/ENGINE			38	3Y8 M
TELAIO/FRAME			27	3Y8 T
CARENA/FAIRING			70	3Y8 C
YAMAHA R6	05	05		
MOTORE/ENGINE			38	5Y6 M
TELAIO/FRAME			26	5Y6 T
CARENA/FAIRING			76	5Y6 C

MODELLO model	ANNO year		QUANTITA' pieces	CODICE code
	DAL from	AL to		
YAMAHA				
YAMAHA R6	06	07		
MOTORE/ENGINE			32	6Y6 M
TELAIO/FRAME			28	6Y6 T
CARENA/FAIRING			60	6Y6 C
YAMAHA R6	08			
MOTORE/ENGINE			32	8Y6 M
TELAIO/FRAME			22	8Y6 T
CARENA/FAIRING			54	8Y6 C
YAMAHA R1	02	03		
MOTORE/ENGINE			29	2Y1 M
TELAIO/FRAME			27	2Y1 T
CARENA/FAIRING			51	2Y1 C
GANCI RAPIDI/QUICK FAIRING FASTENERS			14	2Y1 GR
YAMAHA R1	04	06		
MOTORE/ENGINE			26	4Y1 M
TELAIO/FRAME			28	4Y1 T
CARENA/FAIRING			62	4Y1 C
GANCI RAPIDI/QUICK FAIRING FASTENERS			18	4Y1 GR
YAMAHA R1	07	08		
MOTORE/ENGINE			33	7Y1 M
TELAIO/FRAME			33	7Y1 T
CARENA/FAIRING			52	7Y1 C
GANCI RAPIDI/QUICK FAIRING FASTENERS			12	7Y1 GR
YAMAHA MT-03	06	08		
MOTORE/ENGINE			30	6YM M
TELAIO/FRAME			25	6YM T
CARENA/FAIRING			44	6YM C

STARTER KIT



STARTER KIT BASE
(solo viteria / only bolts and screws)

KITSK



STARTER KIT BRAKE
(raccorderia freno + guaina + tubo in treccia / brake screws + thermo shrinking+teflon hose)

KITSKB

Colori disponibili: rosso, blu, oro.
Available colours: red, blue, gold.

KIT VITI TAPPO SERBATOIO
fuel tank cap screws kit

KIT VITI CUPOLINO
windscreen screws kit

MODELLO model	ANNO year		CODICE code
	DAL from	AL to	
APRILIA			
APRILIA RS 125	97	98	KTA125
APRILIA RS 125	99		KTA1000
APRILIA RSV 1000	04	05	KTA1000
APRILIA Tuono			KTA1000
BENELLI			
BENELLI TNT	04	08	KTA1000
DUCATI			
DUCATI			KTD
GUZZI			
GUZZI GRISO	05	07	KTGG
HONDA			
HONDA CBR 600		00	KTH
HONDA CBR 600	01	08	KTH01
HONDA CBR 900		01	KTH
HONDA CBR 900	02	03	KTH01
HONDA CBR 1000	04	08	KTH01
HONDA CB 1000 R	08		KTH01
HONDA X11			KTH
HONDA SP1			KTH
HONDA SP2			KTH01
HONDA HORNET 600	03	08	KTH01
HONDA HORNET 900	02	07	KTH01
KAWASAKI			
KAWASAKI ZX7R	98	99	KTK
KAWASAKI ZX6R	98	99	KTK
KAWASAKI ZX6R	00	06	KTK5
KAWASAKI ZX6R	07	08	KTK1
KAWASAKI ZX9R	98	99	KTK
KAWASAKI ZX9R	00		KTK5
KAWASAKI ER-6N	06	08	KTK5
KAWASAKI ZX12R			KTK4
KAWASAKI Z1000	03		KTK1
KAWASAKI ZX10R	04	08	KTK1
KAWASAKI Z750	04	08	KTK1
MV			
MV AGUSTA			KTY5
SUZUKI			
SUZUKI GSXR 1000	03	08	KTYT
SUZUKI GSXR 600/750	04	08	KTYT
SUZUKI GSR 600	06	08	KTYT
SUZUKI SV 650	05	08	KTYT
SUZUKI tutte escluso cod. KTYT all excluded code KTYT			KTS
TRIMPH			
TRIUMPH			KTYB
YAMAHA			
YAMAHA R6	99	00	KTY
YAMAHA R6	01	02	KTY5
YAMAHA R6	03	08	KTYT
YAMAHA R1	98	00	KTY
YAMAHA R1	01	03	KTY5
YAMAHA R1	04	08	KTYT
YAMAHA FAZER 600	99	03	KTY
YAMAHA FZ6 + FAZER 600	04	08	KTYT
YAMAHA FAZER 1000	01	05	KTY5
YAMAHA FZ1	06	08	KTYT
YAMAHA BT 1100			KTYB
YAMAHA TDM 900	02		KTYT

MODELLO model	ANNO year		QUANTITA' pieces	CODICE code
	DAL from	AL to		
APRILIA				
APRILIA TUONO 1000	03	05	8	KC001
APRILIA RSV 1000	01	03	16	KC003
APRILIA RSV 1000	04	05	8	KC050
DUCATI				
DUCATI 748-916-996-749-999			9	KC009
DUCATI MONSTER S4	01	02	4	KC010
DUCATI DS 1000	03	08	13	KC011
DUCATI 1098	07	08	8	KC054
DUCATI 848	08		8	KC054
HONDA				
HONDA CBR 900	97	99	6	KC013
HONDA CBR 1000	04	07	6	KC013
HONDA CBR 1000	08		4	KC015
HONDA CBR 600 F	01	02	6	KC013
HONDA CBR 600 S	01	02	6	KC013
HONDA CBR 600	03	06	6	KC013
HONDA CBR 600	07	08	8	KC028
HONDA SP1 + SP2			6	KC013
HONDA CBR 900 RR	00	01	12	KC016
HONDA CBR RR 950	02	03	13	KC019
HONDA HORNET 600	03	06	8	KC051
HONDA HORNET 600	07	08	2	KC053
KAWASAKI				
KAWASAKI ZX12 R	00		6	KC025
KAWASAKI ZX6R	00	02	6	KC025
KAWASAKI ZX6 R	03	04	8	KC028
KAWASAKI ZX6R	05	08	6	KC025
KAWASAKI ZX9R	00	03	6	KC025
KAWASAKI ZX10	04	08	6	KC025
KAWASAKI Z 1000	03	06	4	KC015
KAWASAKI Z1000	07	08	4	KC055
KTM				
KTM SUPER DUKE 990	08		4	KC056
MV				
F4 750	00	03	10	KC030
F4 1000	04	08	10	KC030
SUZUKI				
SUZUKI GSXR 600/750	00	00	14	KC047
SUZUKI GSXR 600/750	01	03	6	KC048
SUZUKI GSXR 600/750	04	05	4	KC040
SUZUKI GSXR 600/750	06	08	6	KC042
SUZUKI GSXR 1000	01	02	6	KC048
SUZUKI GSXR 1000	03	04	12	KC052
SUZUKI GSXR 1000	05	08	6	KC042
SUZUKI SV 650 S	99	02	10	KC046
TRIUMPH				
TRIUMPH DAYTONA 675	07	08	8	KC022
YAMAHA				
YAMAHA FAZER 600	99	03	8	KC033
YAMAHA FAZER 600 + FZ6	04	06	6	KC049
YAMAHA FAZER 1000	01	05	8	KC033
YAMAHA R1	98	06	6	KC013
YAMAHA R6	99	00	6	KC035
YAMAHA R6	01	02	8	KC036
YAMAHA R6	03	08	4	KC015



VETRORESINA E
CARBONIO
FIBERGLASS AND
CARBON

TEAM GIL MOTOR SPORT:
CHRIS WALKER, KATSUAKI FUJIWARA



MODELLO model	VETRORESINA FIBERGLASS		CARBONIO CARBON	
	CODICE code		CODICE code	
HONDA				
HONDA CBR 600 03>04				
CARENA RACING / RACING FAIRING	VETH7127			
CODONE MONOPOSTO / SEAT MONO RACING	VETH7128			
COPERCHIO SERBATOIO / TANK COVER	VETH7129			
PARAFANGO ANT. / FRONT MUDGUARD			CARH7110	
PARAFANGO POST. / REAR MUDGUARD			CARH7120	
COPERCHIO FRIZIONE / CLUTCH COVER			CARH7130	
COPERCHIO ALTERNATORE / ELECTRIC COVER			CARH7140	
PROTEZIONI TELAIO / FRAME PROTECTOR			CARH7150	
PROTEZIONI FORCELLONE / ARM PROTECTOR			CARH7160	
HONDA CBR 600 - 05>06				
CARENA RACING / RACING FAIRING	VETH8927			
CODONE MONOPOSTO / SEAT MONO RACING	VETH8928			
COPERCHIO SERBATOIO / TANK COVER	VETH8929			
PARAFANGO ANT. / FRONT MUDGUARD			CARH8910	
PARAFANGO POST. / REAR MUDGUARD			CARH8920	
COPERCHIO FRIZIONE / CLUTCH COVER			CARH8930	
COPERCHIO ALTERNATORE / ELECTRIC COVER			CARH8940	
PROTEZIONI TELAIO / FRAME PROTECTOR			CARH8950	
PROTEZIONI FORCELLONE / ARM PROTECTOR			CARH8960	
SUPP. STRUMENTI / TACHOMETER SUPPORT			CARH8970	
HONDA CBR 600 >07-08				
CARENA RACING / RACING FAIRING	VETH6527			
CODONE MONOPOSTO/SEAT MONO	VETH6528			
COPERCHIO SERBATOIO / TANK COVER	VETH6529			
PARAFANGO ANT./FRONT MUDGUARD			CARH6510	
PARAFANGO POST./REAR MUDGUARD			CARH8920	
COPERCHIO FRIZIONE/CLUTCH COVER			CARH6530	
COPERCHIO ALTERNATORE/ELECTRIC COVER			CARH6540	
PROTEZIONI TELAIO/FRAME PROTECTORS			CARH6550	
PROTEZIONI FORCELLONE/ARM PROTECTORS			CARH6560	
HONDA CBR 1000 - 04>05				
CARENA RACING / RACING FAIRING	VETH7427			
CODONE MONOPOSTO / SEAT MONO RACING	VETH7428			
COPERCHIO SERBATOIO / TANK COVER	VETH7429			
PARAFANGO ANT. / FRONT MUDGUARD			CARH7410	
PARAFANGO POST. / REAR MUDGUARD			CARH7420	
COPERCHIO FRIZIONE / CLUTCH COVER			CARH7430	
COPERCHIO ALTERNATORE / ELECTRIC COVER			CARH7440	
PROTEZIONI TELAIO / FRAME PROTECTOR			CARH7450	
PROTEZIONI FORCELLONE / ARM PROTECTOR			CARH7414	

MODELLO model	VETRORESINA FIBERGLASS		CARBONIO CARBON	
	CODICE code		CODICE code	
HONDA				
HONDA CBR 1000 - 06>07				
CARENA RACING / RACING FAIRING	VETH6227			
CODONE MONOPOSTO / SEAT MONO RACING	VETH6228			
COPERCHIO SERBATOIO / TANK COVER	VETH6229			
PARAFANGO ANT. / FRONT MUDGUARD			CARH6210	
PARAFANGO POST. / REAR MUDGUARD			CARH7420	
COPERCHIO FRIZIONE / CLUTCH COVER			CARH7430	
COPERCHIO ALTERNATORE / ELECTRIC COVER			CARH7440	
PROTEZIONI TELAIO / FRAME PROTECTOR			CARH7450	
PROTEZIONI FORCELLONE / ARM PROTECTOR			CARH7414	
HONDA CBR 1000 - 08				
CARENA RACING / RACING FAIRING	VETH7627			
CODONE MONOPOSTO / SEAT MONO RACING	VETH7628			
PARAFANGO ANT. / FRONT MUDGUARD			CARH7610	
PARAFANGO POST. / REAR MUDGUARD			CARH7620	
COPERCHIO ALTERNATORE / ELECTRIC COVER			CARH7640	
COPERCHIO FRIZIONE / CLUTCH COVER			CARH7630	
PROTEZIONI TELAIO / FRAME PROTECTOR			CARH7650	
PROTEZIONI FORCELLONE / ARM PROTECTOR			CARH7660	
KAWASAKI				
KAWASAKI ZX6 >07-08				
CARENA RACING/RACING FAIRING	VETK6327			
CODONE MONOPOSTO/SEAT MONO	VETK6328			
PARAFANGO ANT./FRONT MUDGUARD			CARK6310	
COPERCHIO PICK UP/PICK UP COVER			CARK6318	
COPERCHIO FRIZIONE/CLUTCH COVER			CARK6330	
COPERCHIO ALTERNATORE/ELECTRIC COVER			CARK6340	
PROTEZIONI TELAIO/FRAME PROTECTORS			CARK6350	
PROTEZIONI FORCELLONE/ARM PROTECTORS			CARK6314	
KAWASAKI ZX10 06>07				
CARENA RACING / RACING FAIRING	VETK6127			
CODONE MONOPOSTO / SEAT MONO RACING	VETK6128			
PARAFANGO ANT. / FRONT MUDGUARD			CARK6110	
PARAFANGO POST. + COPRI CATENA / REAR MUDGUARD + CHAIN PROTECTOR			CARK6120	
COPERCHIO FRIZIONE / CLUTCH COVER			CARK6130	
COPERCHIO ALTERNATORE / ELECTRIC COVER			CARK6140	
COPERCHIO PICK UP / PICK UP COVER			CARK6118	
PROTEZIONI TELAIO / FRAME PROTECTOR			CARK6150	
PROTEZIONI FORCELLONE / ARM PROTECTOR			CARK6114	



MODELLO model	VETRORESINA FIBERGLASS		CARBONIO CARBON	
	CODICE code		CODICE code	
KAWASAKI				
KAWASAKI ZX10 08				
CARENA RACING / RACING FAIRING	VETK9227			
CODONE MONOPOSTO / SEAT MONO RACING	VETK9228			
PARAFANGO ANT. / FRONT MUDGUARD			CARK9210	
PARAFANGO POST. / REAR MUDGUARD			CARK9220	
COPERCHIO ALTERNATORE / ELECTRIC COVER			CARK6140	
COPERCHIO FRIZIONE / CLUTCH COVER			CARK9230	
COPERCHIO PICK UP / PICK UP COVER			CARK6118	
PROTEZIONI TELAIO / FRAME PROTECTOR			CARK9250	
PROTEZIONI FORCELLONE / ARM PROTECTOR			CARK9260	
MV AGUSTA				
F4 750 00>03 e F4 1000 >04				
PARAFANGO ANT. / FRONT MUDGUARD			CARM9810	
PARAFANGO POST. / REAR MUDGUARD			CARM9820	
TUBI AIR BOX / AIR BOX TUBES			CARM9890	
PROTEZIONI FORCELLONE / ARM PROTECTOR			CARM9814	
SUZUKI				
SUZUKI GSXR 600-750 04>05				
CARENA RACING / RACING FAIRING	VETS8427			
CODONE MONOPOSTO / SEAT MONO RACING	VETS8428			
PARAFANGO ANT. / FRONT MUDGUARD			CARS8410	
PARAFANGO POST. / REAR MUDGUARD			CARS8420	
COPERCHIO FRIZIONE / CLUTCH COVER			CARS8430	
COPERCHIO ALTERNATORE / ELECTRIC COVER			CARS8440	
COPERCHIO PICK UP / PICK UP COVER			CARS8418	
PROTEZIONI TELAIO / FRAME PROTECTION			CARS8450	
TUBI AIR BOX / AIR BOX TUBES			CARS8419	
SUZUKI GSXR 600-750 06>07				
CARENA RACING / RACING FAIRING	VETS6027			
CODONE MONOPOSTO / SEAT MONO RACING	VETS6028			
PARAFANGO ANT. / FRONT MUDGUARD			CARS6010	
PARAFANGO POST. / REAR MUDGUARD			CARS6020	
COPERCHIO FRIZIONE / CLUTCH COVER			CARS6030	
COPERCHIO ALTERNATORE / ELECTRIC COVER			CARS6040	
PROTEZIONI TELAIO / FRAME PROTECTION			CARS6050	
PROTEZIONI FORCELLONE / ARM PROTECTOR			CARS6060	
TUBI AIR BOX / AIR BOX TUBES			CARS6019	
SUPPORTO STRUMENTI / TACHOMETER SUPPORT			CARS6070	

MODELLO model	VETRORESINA FIBERGLASS		CARBONIO CARBON	
	CODICE code		CODICE code	
SUZUKI				
SUZUKI GSXR 600-750 08				
CARENA RACING / RACING FAIRING	VETS8027			
CODONE MONOPOSTO / SEAT MONO RACING	VETS8028			
PARAFANGO ANT. / FRONT MUDGUARD			CARS6010	
PARAFANGO POST. / REAR MUDGUARD			CARS6020	
COPERCHIO ALTERNATORE / ELECTRIC COVER			CARS6040	
COPERCHIO FRIZIONE / CLUTCH COVER			CARS6030	
PROTEZIONI TELAIO / FRAME PROTECTION			CARS6050	
PROTEZIONI FORCELLONE / ARM PROTECTOR			CARS6060	
SUZUKI GSXR 1000 05>06				
CARENA RACING / RACING FAIRING	VETS8827			
CODONE MONOPOSTO / SEAT MONO RACING	VETS8828			
PARAFANGO ANT. / FRONT MUDGUARD			CARS8810	
PARAFANGO POST. / REAR MUDGUARD			CARS8820	
COPERCHIO FRIZIONE / CLUTCH COVER			CARS8830	
COPERCHIO ALTERNATORE / ELECTRIC COVER			CARS8840	
COPERCHIO MOTORINO AVVIAMENTO/STARTER COVER			CARS8818	
PROTEZIONI TELAIO / FRAME PROTECTOR			CARS8850	
PROTEZIONI FORCELLONE / ARM PROTECTOR			CARS8860	
TUBI AIR BOX / AIR BOX TUBES			CARS8819	
SUZUKI GSXR 1000 >07-08				
CARENA RACING / RACING FAIRING	VETS6727			
CODONE MONOPOSTO / SEAT MONO RACING	VETS6728			
PARAFANGO ANT. / FRONT MUDGUARD			CARS8810	
PARAFANGO POST. / REAR MUDGUARD			CARS8820	
COPERCHIO FRIZIONE / CLUTCH COVER			CARS8830	
COPERCHIO ALTERNATORE / ELECTRIC COVER			CARS8840	
COPERCHIO MOTORINO AVVIAMENTO/STARTER COVER			CARS8818	
PROTEZIONI TELAIO / FRAME PROTECTOR			CARS6750	
PROTEZIONI FORCELLONE / ARM PROTECTOR			CARS6760	



ACCESSORI VETRORESINA E CARBONIO fiberglass and carbon parts

MODELLO model	VETRORESINA FIBERGLASS		CARBONIO CARBON	
	CODICE code		CODICE code	
YAMAHA				
YAMAHA YZF R1 04>06				
CARENA RACING / RACING FAIRING	VETY7827			
CODONE MONOPOSTO / SEAT MONO RACING	VETY7828			
PARAFANGO ANT. / FRONT MUDGUARD		CARY7810		
PARAFANGO POST. / REAR MUDGUARD		CARY7820		
COPERCHIO FRIZIONE / CLUTCH COVER		CARY7830		
COPERCHIO ALTERNATORE / ELECTRIC COVER		CARY7840		
COPERCHIO PICK UP/PICK UP COVER		CARY7818		
PROTEZIONI TELAIO / FRAME PROTECTOR		CARY7850		
PROTEZIONI FORCELLONE / ARM PROTECTOR		CARY7860		
TUBI AIR BOX / AIR BOX TUBES		CARY7819		
YAMAHA R1 >07				
CARENA RACING/RACING FAIRING	VETY6627			
CODONE MONOPOSTO/SEAT MONO	VETY6628			
PARAFANGO ANT./FRONT MUDGUARD		CARY7810		
PARAFANGO POST./REAR MUDGUARD		CARY6620		
COPERCHIO FRIZIONE/CLUTCH COVER		CARY6630		
COPERCHIO ALTERNATORE/ELECTRIC COVER		CARY6640		
COPERCHIO PICK UP/PICK UP COVER		CARY6618		
COPERCHIO MOTORE LATO SX/LEFT ENGINE COVER		CARY6648		
PROTEZIONI TELAIO/FRAME PROTECTORS		CARY6650		
PROTEZIONI FORCELLONE/ARM PROTECTORS		CARY6660		
TUBI AIR BOX/AIR BOX TUBES		CARY6619		
YAMAHA YZF R6 - 05				
CARENA RACING / RACING FAIRING	VETY9027			
CODONE MONOPOSTO / SEAT MONO RACING	VETY9028			
PARAFANGO ANT./FRONT MUDGUARD		CARY9010		
PARAFANGO POST./REAR MUDGUARD		CARY9020		
COPERCHIO FRIZIONE/CLUTCH COVER		CARY9030		
COPERCHIO ALTERNATORE/ELECTRIC COVER		CARY9040		
COPERCHIO PICK UP/PICK UP COVER		CARY9018		
PROTEZIONI TELAIO/FRAME PROTECTORS		CARY9050		
TUBI AIR BOX/AIR BOX TUBES		CARY9019		

MODELLO model	VETRORESINA FIBERGLASS		CARBONIO CARBON	
	CODICE code		CODICE code	
YAMAHA				
YAMAHA YZF R6 06>07				
CARENA RACING / RACING FAIRING	VETY9927			
CODONE MONOPOSTO / SEAT MONO RACING	VETY9928			
PARAFANGO ANT. / FRONT MUDGUARD			CARY9910	
PARAFANGO POST. / REAR MUDGUARD			CARY9920	
COPERCHIO FRIZIONE / CLUTCH COVER			CARY9930	
COPERCHIO ALTERNATORE / ELECTRIC COVER			CARY9940	
COPERCHIO PICK UP / PICK UP COVER			CARY9918	
PROTEZIONI TELAIO / FRAME PROTECTION			CARY9950	
PROTEZIONI FORCELLONE / ARM PROTECTOR			CARY9960	
TUBI AIR BOX + SUPPORTO STRUMENTI			CARY9919	
AIR BOX TUBES + TACHOMETER SUPPORT				
YAMAHA YZF R6 08				
CARENA RACING / RACING FAIRING	VETY9627			
CODONE MONOPOSTO / SEAT MONO RACING	VETY9628			
PARAFANGO ANT. / FRONT MUDGUARD			CARY9910	
PARAFANGO POST. / REAR MUDGUARD			CARY9920	
COPERCHIO ALTERNATORE / ELECTRIC COVER			CARY9940	
COPERCHIO FRIZIONE / CLUTCH COVER			CARY9930	
COPERCHIO PICK UP / PICK UP COVER			CARY9918	
PROTEZIONI TELAIO / FRAME PROTECTION			CARY9950	
PROTEZIONI FORCELLONE / ARM PROTECTOR			CARY9960	
YAMAHA FZ1 >06-08				
PARAFANGO ANT. / FRONT MUDGUARD			CARY4010	
PARAFANGO POST. / REAR MUDGUARD			CARY4020	
COPERCHIO FRIZIONE / CLUTCH COVER			CARY4030	
COPERCHIO ALTERNATORE / ELECTRIC COVER			CARY4040	



ARTICOLO
article

CODICE
code



FILLER

rosso, blu, bianco, nero, giallo
red, blue, white, yellow, black

SAPF

NUKE

nero / black

SAPN

DROPPER

ambodestra/both right sides

rosso, blu, bianco, nero, giallo
red, blue, white, yellow, black

SAPDRO

LEATHER

cuoio / leather

SAPL

FIRE TITAN NUKE

nuke con inserti in titanio
nuke with titanium

SAPT

ARTICOLO
article

CODICE
code

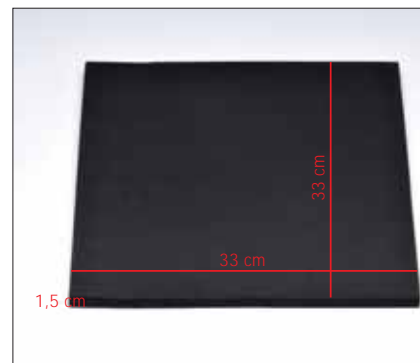

NEOPRENE PER SELLA

neoprene for racing seat

NSR01

**MANOMETRO PER LA PRESSIONE
DEL PNEUMATICO**

TIRE PRESSURE GAUGE

AWG D0A



COPPIA COPRI MANOPOLE

PAIR OF HANDLE COVERS

CM001



CONDIZIONI GENERALI DI VENDITA

PREZZI

I prezzi esposti nel catalogo sono espressi in euro, Iva esclusa.

TRASPORTO

Il trasporto avverrà tramite corriere e le spese di trasporto verranno evidenziate e addebitate in fattura.

TEMPI E MODALITA' DI CONSEGNA

La consegna dei prodotti viene normalmente assicurata entro 15 giorni dal ricevimento dell'ordine.

I prodotti Lightech® possono essere consegnati in tutto il mondo.

RESO MERCE

Nell'eventualità che il cliente riceva un prodotto che presenta delle difettosità o anomalie rispetto a quanto ordinato, Egli dovrà:

1. Entro 5 giorni lavorativi dalla ricezione della consegna, informare il Servizio Clienti Lightech a mezzo fax o via e-mail (ordini@lightech.it), per ricevere le istruzioni circa la restituzione del prodotto difettoso.

PAGAMENTO

Per ordini inferiori ai 100,00, il pagamento della merce avverrà in contassegno e oltre alle spese di trasporto verranno addebitate anche le spese di incasso.

MARCHI

I seguenti marchi registrati con i nomi: Aprilia®, Ducati®, Honda®, Kawasaki®, Mv Agusta®, Suzuki®, Triumph®, Yamaha®, sono di proprietà delle rispettive Case e vengono qui utilizzati a solo titolo descrittivo.

VARIAZIONI AL CATALOGO

Lightech srl, si riserva la facoltà di apportare variazioni sia al presente catalogo che alle presenti condizioni di vendita, in qualsiasi momento e senza preavviso.

AVVERTENZE

I prodotti Lightech® sono stati progettati e realizzati per l'utilizzazione in ambiti agonistici. Lightech® non si assume pertanto alcuna responsabilità per un eventuale uso non corretto dei propri prodotti.

INFORMAZIONE SUI PRODOTTI

Tutti gli articoli inseriti nel catalogo vengono prodotti in Italia presso gli stabilimenti della Lightech srl. Le fotografie, le informazioni e le schede tecniche che illustrano i prodotti e le caratteristiche tecniche, sono di proprietà esclusiva della Lightech srl.

CONTROVERSIE E RESPONSABILITA'

Queste Condizioni Generali sono regolate dalle Leggi Italiane. Per qualsiasi controversia relativa alla validità, interpretazione o esecuzione delle medesime, la competenza territoriale è quella di Treviso.

Colori disponibili: rosso, blu, oro, nero, silver, indaco, ad eccezione di dove diversamente indicato.

SALES CONDITIONS

PREZZI

The prices on catalogue are done in euro. Vat not included.

TRANSPORT

By express courier with transport charges on your account in invoice.

DELIVERY TIMES AND WAY

Normally our delivery times are 15 days from the receiving of the order. Lightech® products can be delivered all over the world.

RETURNS

We accept claims within 5 days from the receiving of the goods. Returns will be accepted only if authorized by Lightech srl. So you have to inform us by fax, by e-mail (ordini@lightech.it) or by phone giving us details about the goods ordered, invoice number and reasons for the returning of them.

PAYMENT

On your choice between PRO-FORMA INVOICE, to pay by advanced bank transfer or Credit Card; CASH ON DELIVERY, with bank charges on invoice.

TRADEMARK

Aprilia®, Ducati®, Honda®, Kawasaki®, Mv Agusta®, Suzuki®, Triumph®, Yamaha®, are registered trademarks, here used only as a reference.

CHANGES

Lightech will be able to change the prices and sales conditions of this catalogue at any moment also without notice for commercial and technical reasons.

NOTICE

All Lightech products are designed and realized only for agonistic use and in a closed circuit.

INFORMATION ABOUT PRODUCTS

All articles on this catalogue are made in Italy. We produce all in our company in Santa Lucia di Piave (TV). The photos and the informations present in the catalogue are Lightech srl property. All rights reserved.

LEGISLATION

This contract shall come under Italian laws. The territorial jurisdiction is Treviso.

Colours available: red, light blue, gold, black, silver, dark blue, except where other colours are indicated.



2008: UN ANNO DI SUCCESSI

LightTech



LighTech Exclusive North American Distributor:



Optimum Performance Products

US Warehouse Facility

**Optimum Performance Products
1160 Yew Avenue
Blaine, WA, USA
98230**

**Phone: 604.942.6744
Fax: 604.942.6745**

Canada Retail Facility

**Optimum Performance Products
101B - 1952 Kingsway Avenue
Port Coquitlam, BC, Canada
V3C 6C2**

**Email: info@oppracing.com
Website: www.oppracing.com**

LighTech

Via Serenissima, 15
31025 S. Lucia di Piave (TV)
Tel. +39 0438 453010
Fax +39 0438 655919
info@lightech.it
www.lightech.it