

2012

**USA & Canada  
Distributor:**



 LightTech

The LightTech logo consists of a stylized yellow symbol on the left, resembling a square with rounded corners and a horizontal bar extending from the top-left corner. To the right of this symbol, the word 'LightTech' is written in a white, sans-serif font.

## **USA Distributor**

OPP Racing  
1927 Boblett Street  
Blaine, WA, USA  
98230



## **Canada Distributor**

OPP Racing  
#101B 1952 Kingsway Ave  
Port Coquitlam, BC, Canada  
V3C 6C2

Website: [www.oppracing.com](http://www.oppracing.com)

Email: [info@oppracing.com](mailto:info@oppracing.com)

Ph# 1-877-942-6744 (toll-free in N. America)

Ph# 1-604-942-6744 (International & BC)

Fax# 1-604-942-6745

**OPP Racing is a performance motorcycle parts distributor, with stocking warehouses in WA, USA and BC, Canada. OPP Racing is responsible for stocking and promoting LighTech products within USA & Canada, as well as facilitating dealer incentive programs and sponsorship opportunities.**

**OPP Racing And LighTech are proud to have a long history together in making premium Italian racing components available to the North American market.**



## listino prezzi | pricelist

### PEDANE | REAR SETS

regolabili - adjustable .....	pag. 12
componenti ricambio - spare parts .....	pag. 16
tenditori catena - chain adjusters .....	pag. 20
supporti cavalletto - swing arm spools .....	pag. 21

### LEVE | LEVERS

leve freno - brake levers .....	pag. 24
leve frizioni - clutch levers .....	pag. 28
KIT leve - KIT levers .....	pag. 30
ricambi leve - levers spare parts .....	pag. 32
mozzetti e tubi - Handlebar holders and handlebar tubes .....	pag. 33

### ACCESSORI MANUBRIO | HANDLEBAR ACCESSORIES

contrappesi manubrio - handle bar balancers .....	pag. 36
regolatori molla forcella - fork spring adjusters .....	pag. 39

### PORTA TARGA | LICENSE PLATE BRACKETS

regolabili - adjustable .....	pag. 42
KIT porta targa - license plate brackets KIT .....	pag. 45
luci - lights .....	pag. 47
resistenze - resistance .....	pag. 48

### PROTEZIONE | PROTECTIONS

protezione telaio - frame sliders .....	pag. 50
protezioni perni ruota - wheel axle sliders .....	pag. 52

### VITERIA | SCREWS

ergal 7075 .....	pag. 54
titanio - titanium .....	pag. 56
special ergal 7075 - 7075 ergal special .....	pag. 58
forate - drilled .....	pag. 60
autofilettanti ergal 7075 - ergal7075 self tapping screws .....	pag. 60
ganci rapidi e ricettacoli - quick fairing and receptacle .....	pag. 61
dadi - nuts .....	pag. 62
rondelle - washers .....	pag. 63
viti dischi freno in titanio - screws for brake disk in titanium .....	pag. 64
tappi telaio - frames caps .....	pag. 64

### KIT VITI | SCREWS KIT

kit viti - screws kit .....	pag. 66
starter kit - starter kit .....	pag. 74
kit viti cupolino - windscreen screws kit .....	pag. 75
kit viti tappo serbatoio - OEM fuel cap screw kit .....	pag. 76

**DADI SPECIAL | SPECIAL NUTS**

dadi special - special nuts ..... pag. 78

**TAPPI | CAPS**

tappi serbatoio - fuel tank caps ..... pag. 84

tappi olio - oil filter caps ..... pag. 86

coperchi pompe freno e frizione - clutch/brake pump reservoir covers ..... pag. 88

**R 1200 GS**

R 1200 GS ..... pag. 92

**T-MAX**

T-MAX ..... pag. 96

**SPECCHI | MIRRORS**

in carbonio - carbon mirrors ..... pag. 102

in alluminio - aluminium mirrors ..... pag. 103

tappo specchio - mirror block-off plates ..... pag. 104

**COMPONENTI IN CARBONIO | CARBON PARTS**

componenti in carbonio - carbons parts ..... pag. 106

**FILTRI ARIA | AIR FILTERS**

filtri aria - air filters ..... pag. 116

**CAVALLETTI | STANDS**

cavalletti - stands ..... pag. 122

**RACING & BOX**

accessori box - box accessories ..... pag. 126

saponette - knee sliders ..... pag. 128

serbatoio rifornimento rapido - fast fuel canister ..... pag. 130

**RACCORDERIA FRENO | BRAKE PARTS**

raccorderia freno - brake parts ..... pag. 132

**COMUNICAZIONE | Communication**

Comunicazione / Communication ..... pag. 135

## LIGHTECH

### italianracingcomponents

Nel 1997, Fabrizio Furlan crea Lightech per portare le competenze produttive della sua famiglia e della sua professione di pilota nell'eccitante mondo delle moto da corsa. Collaborare con prestigiosi team nel Campionato Mondiale Superbike, Moto GP, Moto 2GP e 125 GP ha permesso a Lightech di sviluppare e diventare leader nel campo degli accessori per moto. Oggi, Lightech si sviluppa su una superficie di 2.500 metri quadrati, così suddivisi: 1.400 dedicati alla produzione con sofisticati torni e frese a controllo numerico (CNC), 600 all'area magazzino e stoccaggio, 50 al dipartimento Ricerca e Sviluppo in cui gli ingegneri utilizzano programmi di disegno tecnico (CAD) e produzione (CAM) assistiti da computer per progettare. Oltre alla sede principale, Lightech dispone di un altro stabilimento di 1.600 metri quadrati dotato di impianti per la produzione di pedane, leve freno-frizione e portatarga.

**Lightech è certificata**  
**UNI EN ISO/9001: 00 e TUV.**

Il catalogo Lightech contiene più di 7.000 prodotti in Ergal che sono realizzati in diverse colorazioni, 400 prodotti in titanio ed una serie di numerosi altri accessori. Lightech può contare su di una rete vendita strutturata attualmente in oltre 1.500 rivenditori autorizzati in Italia e distributori in 20 altri paesi. Tale rete è in continuo ampliamento.



## LIGHTECH italianracingcomponents



Jorge Lorenzo



Michel Fabrizio



In 1997, Fabrizio Furlan created LighTech to bring his family's manufacturing expertise to the exciting world of motorcycle racing. Working closely with elite teams in the World Superbike Championship, Moto GP, 125 GP and Moto 2GP has allowed LighTech to become a leader of technologically advanced motorcycle performance parts and accessories. Today, the LighTech factory houses 2,500 square meters of which 1,400 dedicated to production with sophisticated computer-numeric-control (CNC) machines, 600 to storage area and 50 to research and development department where engineers use state-of-the-art computer-assisted design (CAD) and computer-assisted manufacturing (CAM) programs. In addition to the main factory, LighTech has a subsidiary with a 1,600 square meter facility for producing rear-sets, brake and clutch levers and license plate brackets. And of course,

**LighTech is  
UNI EN ISO/9001:00 certified by TUV.**

The scope of LighTech is enormous. The LighTech catalog contains over 7,000 ergal products that are manufactured in seven different colours, over 400 titanium products and a host of other accessories. LighTech has more than 1,500 authorized dealers in Italy and distributors in 20 countries.

# IN PISTA CON LIGHTTECH

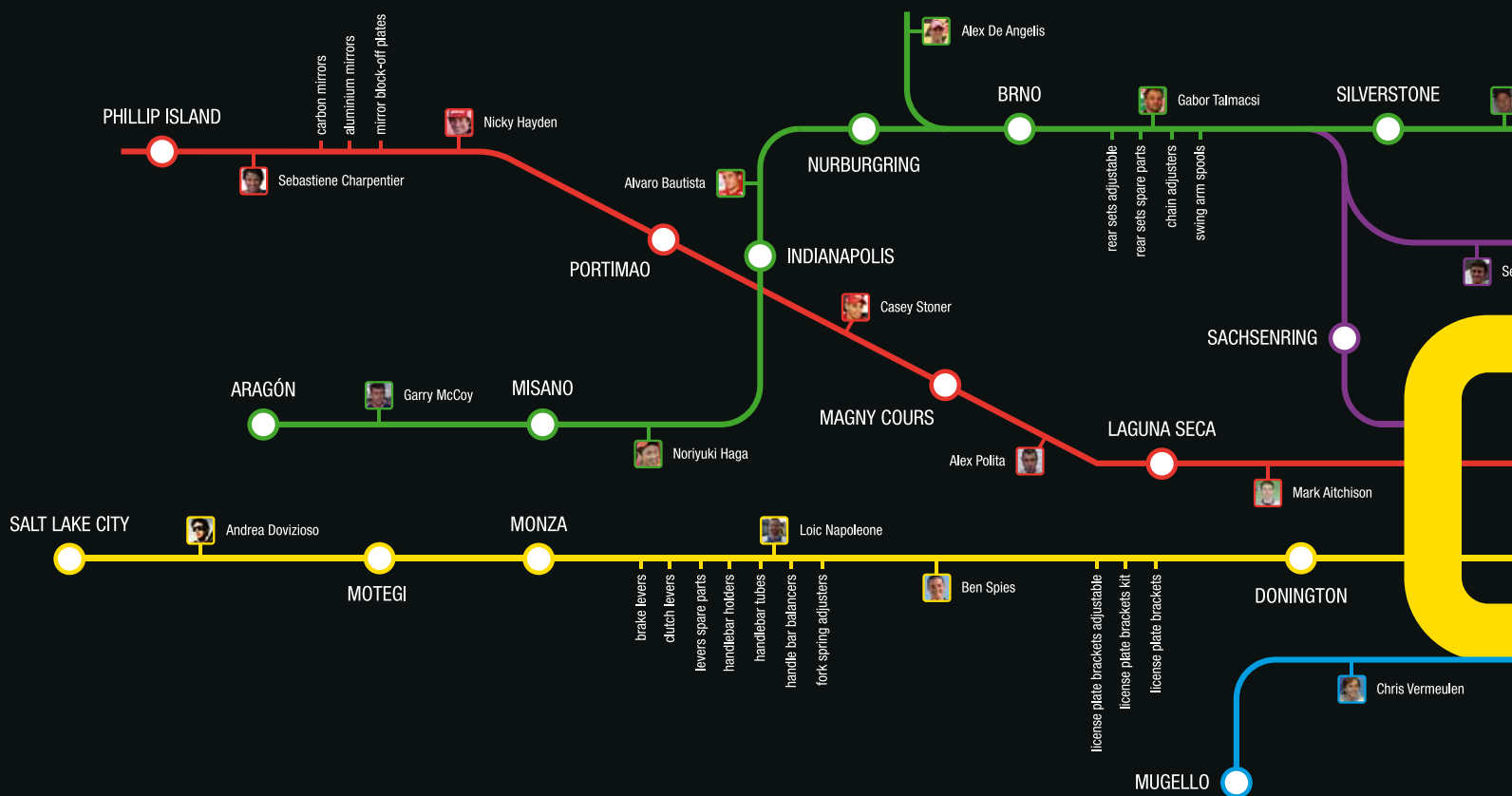
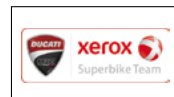

# LIGH TECH MAP

Anni di sponsorizzazioni tecniche, l'utilizzo di un design e metodi di produzione all'avanguardia, e la passione per la moto da corsa, sono le ragioni per cui si trovano qualità e innovazione in ogni prodotto LighTech.

Years of technical sponsorship, the use of cutting edge design and production methods and a passion for motorcycle racing are the reasons why you will find quality and innovation in every LighTech product. You can definitely believe that.





# THE RACE OF LIGHTTECH



## 2012 TECHNICAL SPONSOR

- Yamaha Factory Racing · MotoGP  
Jorge Lorenzo | Ben Spies
- Monster Yamaha Tech 3 · MotoGP  
Colin Edwards | Cal Crutchlow
- Althea Racing · SBK  
Carlos Checa
- Team Suzuki Alstare · SBK  
Michel Fabrizio

- JIR · Moto2  
Alex De Angelis
- Tech 3 B · Moto2  
Xavier Simeon
- Tech 3 Racing  
Bradley Smith | Mike Di Meglio
- Alstare Suzuki  
Leon Haslam | Sylvain Guintoli

- Althea Racing · STK 1000  
Davide Giugliano | Lorenzo Baroni
- Althea Racing · CIV  
Federico Sandi | Luca Conforti |  
Flavio Gentile
- Honda CBR600RR Cup
- Honda NSF 100 Trophy Extreme
- Honda HIRP



LightTech

RSV4

LightTech

Brembo



## **PEDANE REAR SETS**

## Pedane regolabili con poggiatesta fisso

Adjustable rear sets with fixed footpeg

modello - model	track system	anno - years		cambio rovesciato reverse shifting	codice - code	€
		dal - from	al - to			
<b>APRILIA</b>						
APRILIA RSV4 / FACTORY	OK	09	11	OK	FTRAP001	
APRILIA TUONO V4	OK	11		OK	FTRAP001	
<b>BMW</b>						
BMW S1000RR	OK	09	11	NO	FTRBM001	
BMW S1000RR	OK	09	11	OK	FTRBM002	
<b>DUCATI</b>						
DUCATI 749 / 999	-	02	06	OK	FTR02D999	
DUCATI 848 / 1098 / 1198	OK	07	11	OK	FTRDU001	
DUCATI STREET FIGHTER	OK	09	11	OK	FTRDU002	
<b>HONDA</b>						
HONDA CBR 600	-	03	06	OK	FTR02CBR605S	
HONDA CBR 600	OK	07	11	OK	FTRHO003	
HONDA CBR 1000	-	04	07	OK	FTR02CBR104	
HONDA CBR 1000RR (anche con ABS / also with ABS)	OK	08	11	OK	FTRHO002	
HONDA CB 1000R	OK	08	11	OK	FTRHO001	
<b>KAWASAKI</b>						
KAWASAKI ZX6R	-	05	11	OK	FTR02KZX605	
KAWASAKI ZX10R	-	06	07	OK	FTR02KZX1006	
KAWASAKI ZX10R	-	08	10	OK	FTR02KZX1008	
KAWASAKI Z 750	OK	07	11	OK	FTRKA001	
KAWASAKI Z 1000	OK	10	11	OK	FTRKA002	
KAWASAKI ZX10R	OK	11	11	OK	FTRKA003	
KAWASAKI Z 1000 SX	OK	11		OK	FTRKA002	
<b>MV</b>						
MV BRUTALE + F4	OK	00	10	OK	FTRMV001	
<b>SUZUKI</b>						
SUZUKI GSXR 600 / 750	-	06	10	OK	FTR02GSXR606	
SUZUKI GSXR 1000	-	05	06	OK	FTR02GSXR105	
SUZUKI GSXR 1000	-	07	08	OK	FTR02GSXR107	
SUZUKI GSXR 1000	-	09	11	OK	FTRSU001	
SUZUKI GSXR 600 / 750	OK	11		OK	FTRSU002	
<b>TRIUMPH</b>						
TRIUMPH SPEED TRIPLE 1050	-	05	08	OK	FTR02SPEED05	
per cambio rovesciato no cavalletto laterale for reverse shifting remove the stand						
TRIUMPH DAYTONA 675	OK	07	11	NO	FTRTR001	
<b>YAMAHA</b>						
YAMAHA R6	OK	06	07	OK	FTRYA005	
YAMAHA R6	OK	08	11	OK	FTRYA002	
YAMAHA R1	OK	07	08	OK	FTRYA003	
YAMAHA R1	OK	09	11	OK	FTRYA001	
YAMAHA FZ1	OK	06	11	NO	FTRYA004	
YAMAHA FZ1	OK	10	11	NO	FTRYA004	

**Pedane regolabili con poggiatesta fisso**

Adjustable rear sets with fixed footpeg

**DUCATI STREETFIGHTER****APRILIA RSV4****YAMAHA FZ1****DUCATI 1198****SUZUKI GSXR 600 / 750****KAWASAKI ZX10R**

## Pedane regolabili con poggiatele snodato

Adjustable rear sets with fold up footpeg

modello - model	track system	anno - years		cambio rovesciato reverse shifting	codice - code	€
		dal - from	al - to			
<b>APRILIA</b>						
APRILIA RSV4 / FACTORY	OK	09	11	OK	FTRAP001W	
APRILIA RSV4 / FACTORY LIMITED EDITION	OK	09	11	OK	FTRAP001LTD	
APRILIA TUONO V4	OK	11		OK	FTRAP001W	
<b>BMW</b>						
BMW S1000RR	OK	09	11	NO	FTRBM001W	
BMW S1000RR	OK	09	11	OK	FTRBM002W	
BMW S1000RR	OK	09	11	NO	FTRBM001LTD	
BMW S1000RR	OK	09	11	OK	FTRBM002LTD	
<b>DUCATI</b>						
DUCATI 749 / 999	-	02	06	OK	FTR02D999W	
DUCATI 848 / 1098 / 1198	OK	07	11	OK	FTRDU001W	
DUCATI STREET FIGHTER	OK	09	11	OK	FTRDU002W	
<b>HONDA</b>						
HONDA CBR 600	-	03	06	OK	FTR02CBR605SW	
HONDA CBR 600	OK	07	11	OK	FTRHO003W	
HONDA CBR 1000	-	04	07	OK	FTR02CBR104W	
HONDA CBR 1000RR (anche con ABS / also with ABS)	OK	08	11	OK	FTRHO002W	
HONDA CB 1000R	OK	08	11	OK	FTRHO001W	
<b>KAWASAKI</b>						
KAWASAKI ZX6R	-	05	10	OK	FTR02KZX605W	
KAWASAKI ZX10R	-	06	07	OK	FTR02KZX1006W	
KAWASAKI ZX10R	-	08	10	OK	FTR02KZX1008W	
KAWASAKI Z 750	OK	07	11	OK	FTRKA001W	
KAWASAKI Z 1000	OK	10	11	OK	FTRKA002W	
KAWASAKI ZX10R	OK	11		OK	FTRKA003W	
<b>MV</b>						
MV BRUTALE + F4	OK	00	10	OK	FTRMV001W	
<b>SUZUKI</b>						
SUZUKI GSXR 600 / 750	-	06	10	OK	FTR02GSXR606W	
SUZUKI GSXR 1000	-	05	06	OK	FTR02GSXR105W	
SUZUKI GSXR 1000	-	07	08	OK	FTR02GSXR107W	
SUZUKI GSXR 1000	-	09	11	OK	FTRSU001W	
SUZUKI GSXR 600 / 750	OK	11		OK	FTRSU002W	
<b>TRIUMPH</b>						
TRIUMPH SPEED TRIPLE 1050	-	05	08	OK	FTR02SPEED05W	
per cambio rovesciato no cavalletto laterale for reverse shifting remove the stand						
TRIUMPH DAYTONA 675	OK	07	11	NO	FTRTR001W	
<b>YAMAHA</b>						
YAMAHA R6	OK	06	07	OK	FTRYA005W	
YAMAHA R6	OK	08	11	OK	FTRYA002W	
YAMAHA R1	OK	07	08	OK	FTRYA003W	
YAMAHA R1	OK	09	11	OK	FTRYA001W	
YAMAHA R1	OK	09	11	OK	FTRYA001LTD	
YAMAHA FZ1	OK	06	11	NO	FTRYA004W	

## Pedane regolabili con poggiatepiede snodato

Adjustable rear sets with fold up footpeg

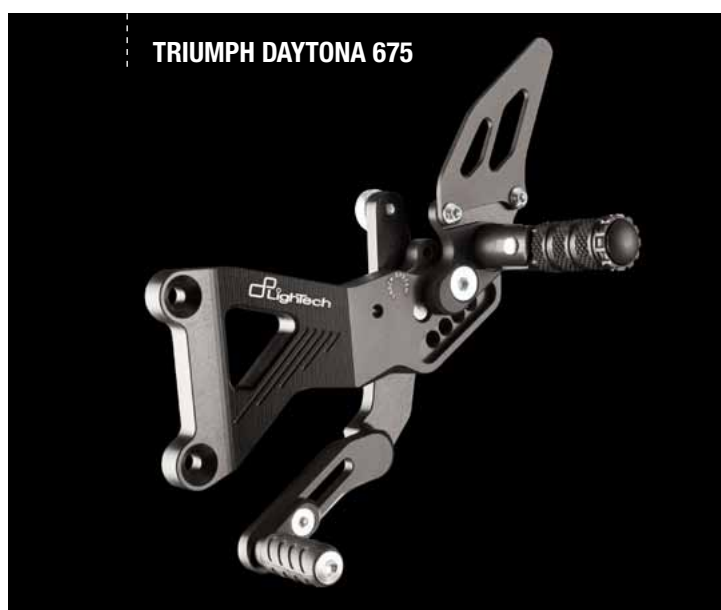

## Pedane Limited Edition

Limited Edition rear sets

APRILIA RSV4  
LIMITED EDITION

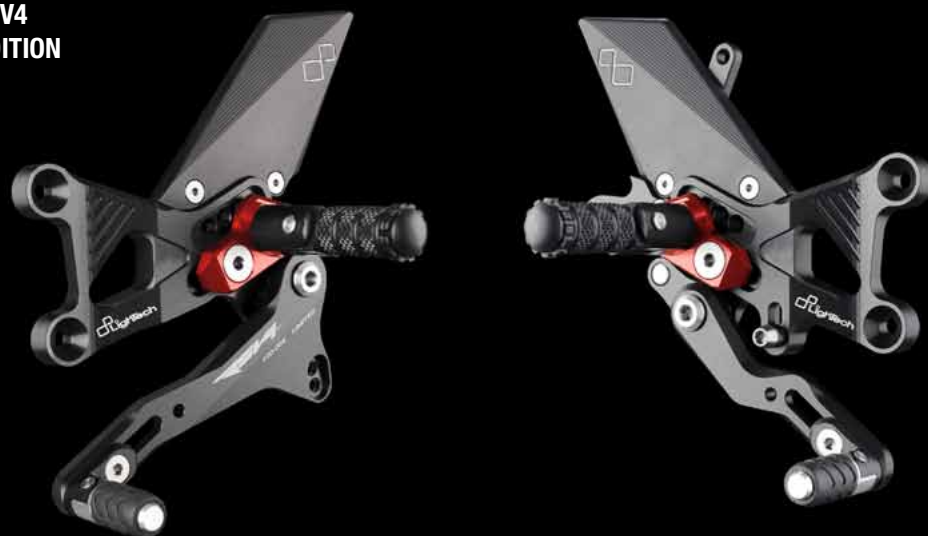

BMW S1000RR  
LIMITED EDITION



YAMAHA R1  
LIMITED EDITION







codice-code: RFTR32

**Poggia piede - fissaggio su leva a cuscinetti**  
Footpeg that attaches to lever



codice-code: RFTR45

**Poggia piede - fissaggio su piastra**  
Footpeg that attaches to support



codice-code: RFTR71

**Poggia piede snodato fissaggio su leva a cuscinetti**  
Folding footpeg that attaches to lever



codice-code: RFTR72

**Poggia piede snodato fissaggio su piastra**  
Folding footpeg that attaches to support



codice-code: RFTR52

**Puntalino**  
Front toe peg



codice-code: RFTR154

**Puntalino snodato**  
Folding front toe peg



codice-code: RFTR156

**Puntalino snodato**  
Folding front toe peg



codice-code: FTR290

**Supporto puntalino**  
Toe peg holder

## Componenti ricambio per pedane

Rear set spare parts



**NEW**

codice-code: FTR469

Alluminio - Aluminium



**NEW**

codice-code: FTR468

Alluminio - Aluminium



**NEW**

codice-code: FTR471

Carbonio - Carbon



**NEW**

codice-code: FTR470

Carbonio - Carbon



codice-code: FTR418

Alluminio - Aluminium



codice-code: FTR419

Alluminio - Aluminium



code: FTR 291 LTD

Supporto poggiatesta  
lato freno  
Footpeg holder brake side



code: FTR 292 LTD

Supporto poggiatesta  
lato cambio  
Footpeg holder shift side



code: FTR 291

Supporto poggiatesta  
lato freno  
Footpeg holder brake side



code: FTR 292

Supporto poggiatesta  
lato cambio  
Footpeg holder shift side



codice-code: FTR 280

Alluminio - Aluminium



codice-code: FTR 282

Alluminio - Aluminium



codice-code: FTR 286

Alluminio - Aluminium



codice-code: FTR 313

Alluminio - Aluminium



codice-code: FTR 281

Carbonio - Carbon



codice-code: FTR 283

Carbonio - Carbon



Uniball

Mas M6 dx = VAR1036  
Mas M6 sx = VAR1077



Uniball

Fem M6 dx = VAR1095  
Fem M6 sx = VAR1076



codice-code: FTR236

Millerighe - Gear shift arm



codice-code: RFTR93

Interruttore stop idraulico (M10 x 1,25)  
Hydraulic stop switch (M10 x 1,25)



codice-code: RFTR128

Interruttore stop idraulico (M10 x 1)  
Hydraulic stop switch (M10 x 1)



codice-code: FTR429

Millerighe - Gear shift arm



Alluminio - Aluminium

mm 155 · cod. FTR 75  
mm 165 · cod. FTR 252  
mm 175 · cod. FTR 365  
mm 180 · cod. FTR 184  
mm 190 · cod. FTR 62  
mm 197 · cod. FTR 97  
mm 205 · cod. FTR 163  
mm 220 · cod. FTR 238  
mm 240 · cod. FTR 32



Inox - Steel

mm 165 · cod. FTR 329  
mm 175 · cod. FTR 228  
mm 190 · cod. FTR 56

## Tenditori catena

Chain adjusters

modello - model	anno - years		codice - code	€
	dal - from	al - to		
APRILIA RSV4	09	11	TEAP001	
APRILIA TUONO V4	11		TEAP001	
BMW	09	11	TEBM001	
HONDA CBR 600	07	11	TEHO001	
HONDA CBR 1000	06	07	TEH107	
HONDA CBR 1000	08	11	TEHO001	
KAWASAKI ZX6R	07	08	TEZX607	
KAWASAKI ZX6R	09	11	TEZX609	
KAWASAKI ZX10R	08	10	TEZX108	
SUZUKI GSXR 600 / 750	06	10	TESK7	
SUZUKI GSXR 1000	07	08	TESK7	
SUZUKI GSXR 1000	09	11	TESK9	
TRIUMPH DAYTONA 675	07	11	TET675	
YAMAHA R6	06	11	TEY608	
YAMAHA R1	07	08	TEY107	
YAMAHA R1	09	11	TEY109	
KAWASAKI ZX10R	11		TEKA001	
SUZUKI GSXR 600 / 750	11		TESU001	



Colori disponibili: nero, indaco, oro, rosso. Available colours: black, indigo, gold, red.

## Forchette tenditori catena

Lifters for chain adjusters

modello - model	anno - years		codice - code	€
	dal - from	al - to		
APRILIA RSV4	09	11	FTEAP001	
APRILIA TUONO V4	11		FTEAP001	
BMW	09	11	FTEBM001	
HONDA CBR 600	07	11	FTEH607	
HONDA CBR 1000	06	11	FTEH607	
KAWASAKI ZX6R	07	11	FTEZX607	
KAWASAKI ZX10R	08	11	FTEZX607	
SUZUKI GSXR 600/750	06	11	FTESK7	
SUZUKI GSXR 1000	07	11	FTESK7	
YAMAHA R1	07	11	FTEY107	
SUZUKI GSXR 600 / 750	11		FTESK7	



Colori disponibili: nero, silver.  
Available colours: black, silver.

## Supporti per cavalletti

Swing arm spools

misura - measure	codice - code	€
		a coppia - for pair
M6	CAVM6	
M8	CAVM8	
M10 X 1,50	CAVM1015	
M10 x 1,25	CAVM10	

CAVM1015 solo in silver e nero. CAVM1015 only in silver or black.

Colori disponibili: rosso, indaco, oro, blu, silver, nero.  
Available colours: red, indigo, gold, blue, silver, black.



misura - measure	codice - code	€
		a coppia - for pair
M6	CAVM6W	
M8	CAVM8W	
M10 x 1,25	CAVM10W	

Colori disponibili: rosso, indaco, oro, blu, nero.  
Available colours: red, indigo, gold, blue, black.





Cal Crutchlow



Alex De Angelis



Mike Di Meglio



Colin Edwards







**LEVE  
LEVERS**

## Leve freno ribaltabile con regolazione da destra

Folding brake levers adjustable from right





Colori disponibili: nero. Available colours: black

modello - model	anno - years		codice - code <b>J</b>	€	codice - code <b>W</b>	€
	dal - from	al - to				
						
<b>BREMBO</b>						
BREMBO (16 x 16) leva corta / short lever			LEVD551J		LEVD551W	
BREMBO (16 x 18) (19 x 18)			LEVD502J		LEVD502W	
BREMBO (16 x 18) (19 x 18) leva corta / short lever			LEVD552J		LEVD552W	
BREMBO (19 x 18)			LEVD555J		LEVD555W	
BREMBO (19 x 20)			LEVD503J		LEVD503W	
BREMBO (19 x 20) leva corta / short lever			LEVD553J		LEVD553W	
<b>APRILIA</b>						
APRILIA RSV1000	04	09	LEVD010J		LEVD010W	
APRILIA RSV4 + factory	09	11	LEVD010J		LEVD010W	
<b>BMW</b>						
BMW S1000 RR	09	11	LEVD012J		LEVD012W	
<b>DUCATI</b>						
DUCATI 749-999	02	06	LEVD010J		LEVD010W	
DUCATI 848-1098-1198	07	11	LEVD010J		LEVD010W	
DUCATI Streetfighter	09	11	LEVD010J		LEVD010W	
DUCATI Monster 1100	10	11	LEVD010J		LEVD010W	
<b>HONDA</b>						
HONDA CBR 954	02	03	LEVD002J		LEVD002W	
HONDA CBR 600	03	06	LEVD002J		LEVD002W	
HONDA CBR 600	07	11	LEVD009J		LEVD009W	
HONDA CBR 600F	11		LEVD004J		LEVD004W	
HONDA CBR 1000	04	11	LEVD009J		LEVD009W	
HONDA CB 1000 R	08	11	LEVD009J		LEVD009W	



## Leve freno ribaltabile con regolazione da destra

Folding brake levers adjustable from right



modello - model	anno - years		codice - code <b>J</b>	€	codice - code <b>W</b>	€
	dal - from	al - to				
						
<b>KAWASAKI</b>						
KAWASAKI ZX6R	00	04	LEVD004J		LEVD004W	
KAWASAKI ZX6R - 636	05	11	LEVD009J		LEVD009W	
KAWASAKI Z750	04	06	LEVD004J		LEVD004W	
KAWASAKI Z750	07	11	LEVD011J		LEVD011W	
KAWASAKI Z750R	11		LEVD009J		LEVD009W	
KAWASAKI Z1000	03	06	LEVD004J		LEVD004W	
KAWASAKI Z1000	07	11	LEVD009J		LEVD009W	
KAWASAKI Z1000 SX	11		LEVD009J		LEVD009W	
KAWASAKI ZX10R	04	05	LEVD004J		LEVD004W	
KAWASAKI ZX10R	06	11	LEVD009J		LEVD009W	
KAWASAKI Versys	06	11	LEVD004J		LEVD004W	
<b>SUZUKI</b>						
SUZUKI tutte / all		03	LEVD004J		LEVD004W	
SUZUKI GSXR 600 / 750	04	11	LEVD009J		LEVD009W	
SUZUKI GSXR 1000	01	04	LEVD004J		LEVD004W	
SUZUKI GSXR 1000	05	11	LEVD009J		LEVD009W	
<b>TRIUMPH</b>						
TRIUMPH Boneville	06	11	LEVD004J		LEVD004W	
TRIUMPH Daytona 675	06	11	LEVD009J		LEVD009W	
TRIUMPH Daytona Speed Triple 955	97	06	LEVD004J		LEVD004W	
TRIUMPH Scrambler	06	11	LEVD004J		LEVD004W	
TRIUMPH Speed Master	05	11	LEVD004J		LEVD004W	
TRIUMPH Speed Triple 1050	04	07	LEVD004J		LEVD004W	
TRIUMPH Speed Triple 1050	08	11	LEVD009J		LEVD009W	
TRIUMPH Street Triple 675 R	09	11	LEVD009J		LEVD009W	
TRIUMPH Tiger 1050	07	11	LEVD004J		LEVD004W	
<b>YAMAHA</b>						
YAMAHA R6	99	04	LEVD004J		LEVD004W	
YAMAHA R6	05	11	LEVD010J		LEVD010W	
YAMAHA R1	98	03	LEVD004J		LEVD004W	
YAMAHA R1	04	11	LEVD010J		LEVD010W	
YAMAHA XJ6	09	11	LEVD013J		LEVD013W	
YAMAHA FZ6 / Fazer	04	11	LEVD013J		LEVD013W	
YAMAHA FZ1 / Fazer	06	11	LEVD013J		LEVD013W	
YAMAHA FZ8	10	11	LEVD013J		LEVD013W	

## Leve freno ribaltabile con regolazione da sinistra

Folding brake levers adjustable from left





Colori disponibili: nero. Available colours: black

modello - model	anno - years		codice - code <b>J</b>	€	codice - code <b>W</b>	€
	dal - from	al - to				
						
<b>BREMBO</b>						
BREMBO (16 x 16) leva corta / short lever			LEVS551J		LEVS551W	
BREMBO (16 x 18) (19 x 18)			LEVS502J		LEVS502W	
BREMBO (16 x 18) (19 x 18) leva corta / short lever			LEVS552J		LEVS552W	
BREMBO (19 x 18)			LEVS555J		LEVS555W	
BREMBO (19 x 20)			LEVS503J		LEVS503W	
BREMBO (19 x 20) leva corta / short lever			LEVS553J		LEVS553W	
<b>APRILIA</b>						
APRILIA RSV1000	04	10	LEVS010J		LEVS010W	
APRILIA RSV4 + factory	09	11	LEVS010J		LEVS010W	
<b>BMW</b>						
BMW S1000 RR	09	11	LEVS012J		LEVS012W	
<b>DUCATI</b>						
DUCATI 749-999	02	06	LEVS010J		LEVS010W	
DUCATI 848-1098-1198	07	11	LEVS010J		LEVS010W	
<b>HONDA</b>						
HONDA CBR 954		03	LEVS002J		LEVS002W	
HONDA CBR 600	03	06	LEVS002J		LEVS002W	
HONDA CBR 600	07	11	LEVS009J		LEVS009W	
HONDA CBR 1000	04	11	LEVS009J		LEVS009W	

## Leve freno ribaltabile con regolazione da sinistra

Folding brake levers adjustable from left





modello - model	anno - years		codice - code <b>J</b>	€	codice - code <b>W</b>	€
	dal - from	al - to				
						
<b>KAWASAKI</b>						
KAWASAKI ZX6R		04	LEVS004J		LEVS004W	
KAWASAKI ZX6R	05	11	LEVS009J		LEVS009W	
KAWASAKI ZX10R	04	05	LEVS004J		LEVS004W	
KAWASAKI ZX10R	06	11	LEVS009J		LEVS009W	
<b>SUZUKI</b>						
SUZUKI tutte / all		03	LEVS004J		LEVS004W	
SUZUKI GSXR 600 / 750	04	11	LEVS009J		LEVS009W	
SUZUKI GSXR 1000	01	04	LEVS004J		LEVS004W	
SUZUKI GSXR 1000	05	11	LEVS009J		LEVS009W	
<b>TRIUMPH</b>						
TRIUMPH Daytona 675	06	11	LEVS009J		LEVS009W	
<b>YAMAHA</b>						
YAMAHA R6	99	04	LEVS004J		LEVS004W	
YAMAHA R6	05	11	LEVS010J		LEVS010W	
YAMAHA R1	98	03	LEVS004J		LEVS004W	
YAMAHA R1	04	11	LEVS010J		LEVS010W	

## Leve frizione ribaltabile per snodo originale

Folding clutch levers for original joint





Colori disponibili: nero. Available colours: black

modello - model	anno - years		codice - code <b>J</b>	€	codice - code <b>W</b>	€
	dal - from	al - to				
						
<b>APRILIA</b>						
APRILIA RSV1000	04	09	LEVXF007J		LEVXF007W	
APRILIA RSV4 + factory	09	11	LEVXF001J		LEVXF001W	
APRILIA TUONO V4	11		LEVXF001J		LEVXF001W	
<b>BMW</b>						
BMW S1000 RR	09	11	LEVXF008J		LEVXF008W	
<b>DUCATI</b>						
DUCATI 749-999	02	06	LEVXF007J		LEVXF007W	
DUCATI 848-1098-1198	07	11	LEVXF007J		LEVXF007W	
DUCATI Monster 1100	10	11	LEVXF007J		LEVXF007W	
DUCATI Monster S4R	07	07	LEVXF007J		LEVXF007W	
DUCATI Streetfighter	09	11	LEVXF007J		LEVXF007W	
<b>HONDA</b>						
HONDA CBR 600	03	11	LEVXF002J		LEVXF002W	
HONDA CBR 600 F	11		LEVXF002J		LEVXF002W	
HONDA CBR 1000	04	07	LEVXF003J		LEVXF003W	
HONDA CBR 1000	08	11	LEVXF002J		LEVXF002W	
HONDA CB 1000 R	08	11	LEVXF003J		LEVXF003W	
HONDA HORNET 600	11		LEVXF002J		LEVXF002W	
<b>KAWASAKI</b>						
KAWASAKI ZX6R	03	11	LEVXF004J		LEVXF004W	
KAWASAKI Z750	04	06	LEVXF005J		LEVXF005W	
KAWASAKI Z750	07	11	LEVXF004J		LEVXF004W	
KAWASAKI Z1000	03	11	LEVXF004J		LEVXF004W	
KAWASAKI Z1000 SX	11		LEVXF004J		LEVXF004W	
KAWASAKI ZX10R	04	11	LEVXF004J		LEVXF004W	
KAWASAKI ZX10R	11		LEVXF010J		LEVXF010W	
KAWASAKI Versys	06	11	LEVXF005J		LEVXF005W	

## Leve frizione ribaltabile per snodo originale



Folding clutch levers for original joint

modello - model	anno - years		codice - code <b>J</b>	€	codice - code <b>W</b>	€
	dal - from	al - to				
						
<b>SUZUKI</b>						
SUZUKI GSXR 600 / 750	06	10	LEVXF001J		LEVXF001W	
SUZUKI GSXR 1000	05	06	LEVXF001J		LEVXF001W	
SUZUKI GSXR 1000	07	08	LEVXF006J		LEVXF006W	
SUZUKI GSXR 1000	09	11	LEVXF001J		LEVXF001W	
SUZUKI GSXR 600 / 750	11		LEVXF011J		LEVXF011W	
<b>TRIUMPH</b>						
TRIUMPH Boneville	06	11	LEVXF009J		LEVXF009W	
TRIUMPH Daytona 675	06	11	LEVXF009J		LEVXF009W	
TRIUMPH Scrambler	06	11	LEVXF009J		LEVXF009W	
TRIUMPH Speed Master	05	11	LEVXF009J		LEVXF009W	
TRIUMPH Speed Triple 1050	04	11	LEVXF009J		LEVXF009W	
TRIUMPH Street Triple 675 R	09	11	LEVXF009J		LEVXF009W	
TRIUMPH Tiger 1050	07	11	LEVXF009J		LEVXF009W	
<b>YAMAHA</b>						
YAMAHA R6	00	11	LEVXF001J		LEVXF001W	
YAMAHA R1	00	11	LEVXF001J		LEVXF001W	
YAMAHA XJ6	09	11	LEVXF001J		LEVXF001W	
YAMAHA FZ6 / Fazer	04	11	LEVXF001J		LEVXF001W	
YAMAHA FZ1 / Fazer	06	11	LEVXF001J		LEVXF001W	
YAMAHA FZ8	10	11	LEVXF001J		LEVXF001W	



### FOR RACING USE ONLY

Colori disponibili: nero. Available colours: black



modello - model	codice - code <b>J</b>	€	codice - code <b>W</b>	€
				
Leva frizione ribaltabile a cavo con bracciale Folding clutch lever (for cable clutch lever)	LEV7100J		LEV7100W	



**KIT leva**

Lever KIT



Colori disponibili: nero. Available colours: black

modello - model	anno - years		codice - code <b>J</b>	€	codice - code <b>W</b>	€
	dal - from	al - to				
						
<b>APRILIA</b>						
APRILIA RSV1000	04	09	KLEV022J		KLEV022W	
APRILIA RSV4 + factory	09	11	KLEV021J		KLEV021W	
<b>BMW</b>						
BMW S1000 RR	09	11	KLEV020J		KLEV020W	
<b>DUCATI</b>						
DUCATI 749-999	02	06	KLEV022J		KLEV022W	
DUCATI 848-1098-1198	07	11	KLEV022J		KLEV022W	
DUCATI Streetfighter	09	11	KLEV022J		KLEV022W	
DUCATI Monster 1100	10	11	KLEV022J		KLEV022W	
<b>HONDA</b>						
HONDA CBR 600	03	06	KLEV024J		KLEV024W	
HONDA CBR 600	07	11	KLEV025J		KLEV025W	
HONDA CBR 1000	04	07	KLEV023J		KLEV023W	
HONDA CBR 1000	08	11	KLEV025J		KLEV025W	
HONDA CB 1000 R	08	11	KLEV023J		KLEV023W	
HONDA CBR 600 F	11		KLEV037J		KLEV037W	

modello - model	anno - years		codice - code <b>J</b>	€	codice - code <b>W</b>	€
	dal - from	al - to				
						
<b>KAWASAKI</b>						
KAWASAKI ZX6R	03	04	KLEV028J		KLEV028W	
KAWASAKI ZX6R	05	11	KLEV029J		KLEV029W	
KAWASAKI Z750	04	06	KLEV026J		KLEV026W	
KAWASAKI Z750	07	11	KLEV027J		KLEV027W	
KAWASAKI Z1000	03	06	KLEV028J		KLEV028W	
KAWASAKI Z1000	07	11	KLEV029J		KLEV029W	
KAWASAKI Z1000 SX	11		KLEV029J		KLEV029W	
KAWASAKI ZX10R	04	05	KLEV028J		KLEV028W	
KAWASAKI ZX10R	06	11	KLEV029J		KLEV029W	
KAWASAKI Versys	06	11	KLEV026J		KLEV026W	
<b>SUZUKI</b>						
SUZUKI GSXR 600 / 750	06	10	KLEV030J		KLEV030W	
SUZUKI GSXR 600 / 750	11		KLEV036J		KLEV036W	
SUZUKI GSXR 1000	05	06	KLEV030J		KLEV030W	
SUZUKI GSXR 1000	07	08	KLEV031J		KLEV031W	
SUZUKI GSXR 1000	09	11	KLEV030J		KLEV030W	
<b>TRIUMPH</b>						
TRIUMPH Boneville	06	11	KLEV033J		KLEV033W	
TRIUMPH Daytona 675	06	11	KLEV032J		KLEV032W	
TRIUMPH Scrambler	06	11	KLEV033J		KLEV033W	
TRIUMPH Speed Master	05	11	KLEV033J		KLEV033W	
TRIUMPH Speed Triple 1050	04	07	KLEV033J		KLEV033W	
TRIUMPH Speed Triple 1050	08	11	KLEV032J		KLEV032W	
TRIUMPH Street Triple 675 R	09	11	KLEV032J		KLEV032W	
TRIUMPH Tiger 1050	07	11	KLEV033J		KLEV033W	
<b>YAMAHA</b>						
YAMAHA R6	05	11	KLEV021J		KLEV021W	
YAMAHA R1	04	11	KLEV021J		KLEV021W	
YAMAHA XJ6	09	11	KLEV034J		KLEV034W	
YAMAHA FZ6 / Fazer	04	11	KLEV034J		KLEV034W	
YAMAHA FZ1 / Fazer	06	11	KLEV034J		KLEV034W	
YAMAHA FZ8	10	11	KLEV034J		KLEV034W	
YAMAHA T-MAX	08	11	KLEV035			

## Ricambi leve

Lever spare parts



LEVA IN MAGNESIO - MAGNESIUM LEVER

codice - code

€

RLEV001J

Colori disponibili: nero. Available colours: black



LEVA IN MAGNESIO - MAGNESIUM LEVER

codice - code

€

RLEV001W

Colori disponibili: nero. Available colours: black



NEW

LEVA IN ERGAL - ERGAL LEVER  
per Brembo RCS for Brembo RCS

codice - code

€

RLEV016

Colori disponibili: nero. Available colours: black



REGISTRO LEVA FRENO - REMOTE BRAKE ADJUSTER  
con supporto with mounting clamp

codice - code

€

RLEV015

Colori disponibili: nero. Available colours: black



CAVO DI REGOLAZIONE - CABLE FOR REMOTE ADJUSTER

codice - code

€

A RLEV005  
B RLEV008  
C RLEV014



Handlebar holders

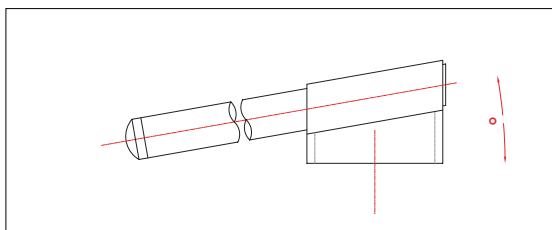

° Inclinazione gradi - ° Inclination grade

Colori disponibili: nero. Available colours: black

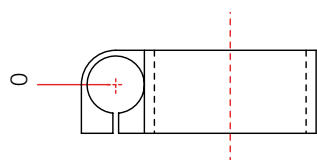

misura - measure	o	codice - code	€
			a coppia - for pair
Ø 48	10	MOZ4810	
Ø 50	10	MOZ5010	
Ø 51	5	MOZ5110	
Ø 52	5	MOZ5210	
Ø 53	10	MOZ5310	
Ø 55	5	MOZ5510	

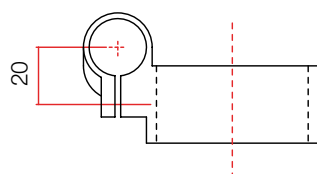

misura - measure	o	codice - code	€
			a coppia - for pair
Ø 48 + 20 mm	10	MOZ4820	
Ø 50 + 20 mm	10	MOZ5020	
Ø 51 + 20 mm	5	MOZ5120	
Ø 52 + 20 mm	5	MOZ5220	
Ø 53 + 20 mm	10	MOZ5320	
Ø 55 + 20 mm	5	MOZ5520	

Tubi

Handlebar tubes

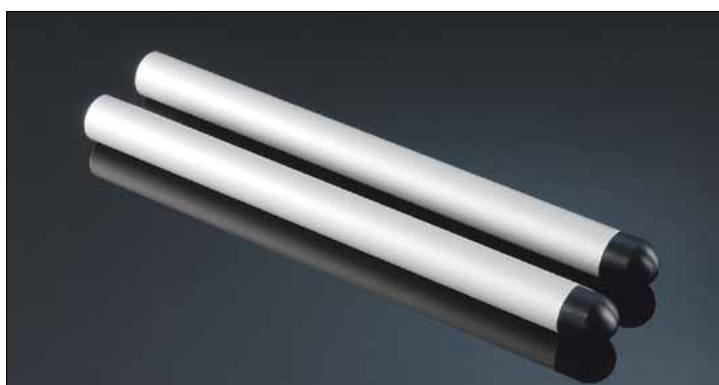

codice - code	€
a coppia - for pair	
HBT001	
lunghezza 280 mm - length 280 mm	





**ACCESSORI  
MANUBRIO**  
HANDLEBAR  
ACCESSORIES

## Contrappesi manubri

Handlebar balancers

**NEW**



## Black & White Series

Colori disponibili: nero e silver. Available colours: black and silver.

modello - model	anno - years		misura - measure	codice - code	€
	dal - from	al - to			
UNIVERSALE / universal			ø 12 / 13 / 17	KTM301	
APRILIA RSV4	09	11		KTM303	
APRILIA RSV1000	04	08		KTM313	
APRILIA Shiver 750	07	11		KTM313	
APRILIA Tuono	06	09		KTM313	
APRILIA Tuono V4	11			KTM313	
BMW S1000RR	09	11		KTM314	
DUCATI S4 - ST2	07	07		KTM304	
DUCATI Multistrada	03	09		KTM305	
DUCATI 848	08	11		KTM301	
DUCATI 1098 / 1198	07	11		KTM302	
HONDA - tutte / all	...	...		KTM306	
KAWASAKI 250R	09	11		KTM307	
KAWASAKI Z750	04	11		KTM304	
KAWASAKI Z1000	03	11		KTM304	
KAWASAKI Z1000 SX	11			KTM304	
KAWASAKI ZX6R	03	11		KTM304	
SUZUKI Gladius 650	09	11		KTM309	
SUZUKI GSR 600	06	11		KTM305	
SUZUKI GSR 750	11			KTM305	
SUZUKI GSXR 600 / 750	00	05		KTM305	
SUZUKI GSXR 600 / 750	06	11		KTM309	
SUZUKI GSXR 1000	03	04		KTM305	
SUZUKI GSXR 1000	05	11		KTM309	
YAMAHA Fazer 600 - FZ6	04	06		KTM310	
YAMAHA Fazer 1000	01	11		KTM310	
YAMAHA T Max	02	11		KTM310	
YAMAHA TDM 900	02	08		KTM310	
YAMAHA R1	98	11		KTM311	
YAMAHA R6	00	05		KTM312	
YAMAHA R6	06	11		KTM311	

## Contrappesi manubri

Handlebar balancers



Colori disponibili: oro, rosso, nero, silver, indaco, blu. Available colours: gold, red, black, silver, indigo, blue.

modello - model	anno - years		misura - measure	codice - code	€
	dal - from	al - to			
UNIVERSALE / universal			ø 12 / 13 / 17	KTM001	
APRILIA RSV4	09	11		KTM003	
APRILIA RSV1000	04	08		KTM013	
APRILIA Shiver 750	07	11		KTM013	
APRILIA Tuono	06	09		KTM013	
APRILIA Tuono V4	11			KTM013	
BMW S1000RR	09	11		KTM014	
BMW R1200GS	08	11		KTM015	
DUCATI S4 - ST2	07	07		KTM004	
DUCATI Multistrada	03	09		KTM005	
DUCATI 848	08	11		KTM001	
DUCATI 1098 / 1198	07	11		KTM002	
HONDA - tutte / all	...	...		KTM006	
KAWASAKI 250R	09	11		KTM007	
KAWASAKI Z750	04	11		KTM004	
KAWASAKI Z1000	03	11		KTM004	
KAWASAKI Z1000 SX	11			KTM004	
KAWASAKI ZX6R	03	11		KTM004	
SUZUKI Gladius 650	09	11		KTM009	
SUZUKI GSR 600	06	11		KTM005	
SUZUKI GSR 750	11			KTM005	
SUZUKI GSXR 600 / 750	00	05		KTM005	
SUZUKI GSXR 600 / 750	06	11		KTM009	
SUZUKI GSXR 1000	03	04		KTM005	
SUZUKI GSXR 1000	05	11		KTM009	
YAMAHA Fazer 600 - FZ6	04	06		KTM010	
YAMAHA Fazer 1000	01	11		KTM010	
YAMAHA T Max	02	11		KTM010	
YAMAHA TDM 900	02	08		KTM010	
YAMAHA R1	98	11		KTM011	
YAMAHA R6	00	05		KTM012	
YAMAHA R6	06	11		KTM011	

## Contrappesi manubrio lisci

Smooth handlebar balancers



**FINO A ESAURIMENTO - TO EXHAUSTION**

Colori disponibili: oro, rosso, nero, silver, indaco, blu. Available colours: gold, red, black, silver, indigo, blue.

modello - model	anno - years		misura - measure	codice - code	€
	dal - from	al - to			
UNIVERSALE / universal			ø 12 / 13 / 17	KTM0212	
APRILIA RSV4	09	11		KTM02A2	
APRILIA RSV1000	04	08		KTM02A	
APRILIA Shiver 750	07	11		KTM02A	
APRILIA Tuono	06	09		KTM02A	
APRILIA Tuono V4	11			KTM02A	
APRILIA Dorsoduro	08	11		KTM02A3	
BMW S1000RR	09	11		KTM02B	
DUCATI S4 - ST2	07	07		KTM02K2	
DUCATI Multistrada	03	09		KTM02S	
DUCATI 848	08	11		KTM0212	
DUCATI 1098 / 1198	07	11		KTM0217	
HONDA - tutte / all	...	....		KTM02H	
KAWASAKI 250R	09	11		KTM02K9	
KAWASAKI Z750	04	11		KTM02K2	
KAWASAKI Z1000	03	11		KTM02K2	
KAWASAKI Z1000 SX	11			KTM02K2	
KAWASAKI ZX6R	03	11		KTM02K2	
SUZUKI Gladius 650	09	11		KTM02S2	
SUZUKI GSR 600	06	11		KTM02S	
SUZUKI GSR 750	11			KTM02S2	
SUZUKI GSXR 600 / 750	00	05		KTM02S	
SUZUKI GSXR 600 / 750	06	11		KTM02S2	
SUZUKI GSXR 1000	03	04		KTM02S	
SUZUKI GSXR 1000	05	11		KTM02S2	
YAMAHA MT03	06	11		KTM02MT	
YAMAHA Fazer 600 - FZ6	04	06		KTM02Y	
YAMAHA Fazer 1000	01	11		KTM02Y	
YAMAHA T Max	02	11		KTM02Y	
YAMAHA TDM 900	02	08		KTM02Y	
YAMAHA R1	98	11		KTM021	
YAMAHA R6	00	05		KTM02R6	
YAMAHA R6	06	11		KTM021	



Colori disponibili: oro, rosso, nero, silver, indaco, blu. Available colours: gold, red, black, silver, indigo, blue.

modello - model	mm	anno - years		codice - code	€
		dal - from	al - to		
APRILIA RSV 4 + Factory	17	09	11	REG001	
APRILIA RSV 1000	17	04	05	REG001	
APRILIA TUONO	22	06	09	REG002	
BMW S1000 RR	17	09	11	REG001	
DUCATI MONSTER 696	17	08	11	REG001	
DUCATI 848 / 1098 / 1198	22	07	11	REG002	
DUCATI 748 / 916 / 996 / 749 / 999	22	00	06	REG002	
GUZZI GRISO	22	06	07	REG002	
HONDA CBR 1000	22	04	07	REG002	
HONDA CBR 1000	19	08	11	REG003	
HONDA CB 1000 R	19	08	11	REG003	
HONDA CBR 600	22	05	06	REG002	
HONDA CBR 600	19	07	11	REG003	
KAWASAKI Z1000	22	03	06	REG002	
KAWASAKI ZX6R	14	03	04	REG004	
KAWASAKI ZX6R	22	05	06	REG002	
KAWASAKI ZX6R	19	07	08	REG003	
KAWASAKI ZX10R	-	04	05	REG005	
KAWASAKI ZX10R	14	06	10	REG004	
MV AGUSTA F4	19	00	09	REG003	
SUZUKI GSXR 600 / 750	22	04	05	REG002	
SUZUKI GSXR 600 / 750	19	06	10	REG003	
SUZUKI GSXR 1000	14	03	08	REG004	
TRIUMPH SPEED TRIPLE 1050	22	05	10	REG002	
TRIUMPH STREET TRIPLE 675	22	07	11	REG002	
TRIUMPH DAYTONA 675	14	07	11	REG004	
YAMAHA R6	17	03	04	REG001	
YAMAHA R6	14	05	05	REG004	
YAMAHA R6	17	06	07	REG001	
YAMAHA R6	14	08	11	REG004	
YAMAHA R1	-	04	11	REG005	
YAMAHA FZ1	14	06	11	REG004	







**PORTA TARGA**  
LICENSE PLATE  
BRACKETS

## Porta targa regolabili

Adjustable license plate brackets

- 1** Materiale ultra-resistente (Polimero PA12 arricchito con fibra di carbonio)  
Ultra resistant material (Polymer PA12 enriched with carbon fiber)
- 2** Struttura rinforzata  
Strengthened structure
- 3** Supporto catadiottro  
Reflector holder
- 4** Fori fissaggio luce targa  
License plate light mounting holes
- 5** Supporto metallico  
Metal holder

Semplicità nel montaggio  
Easy assembling

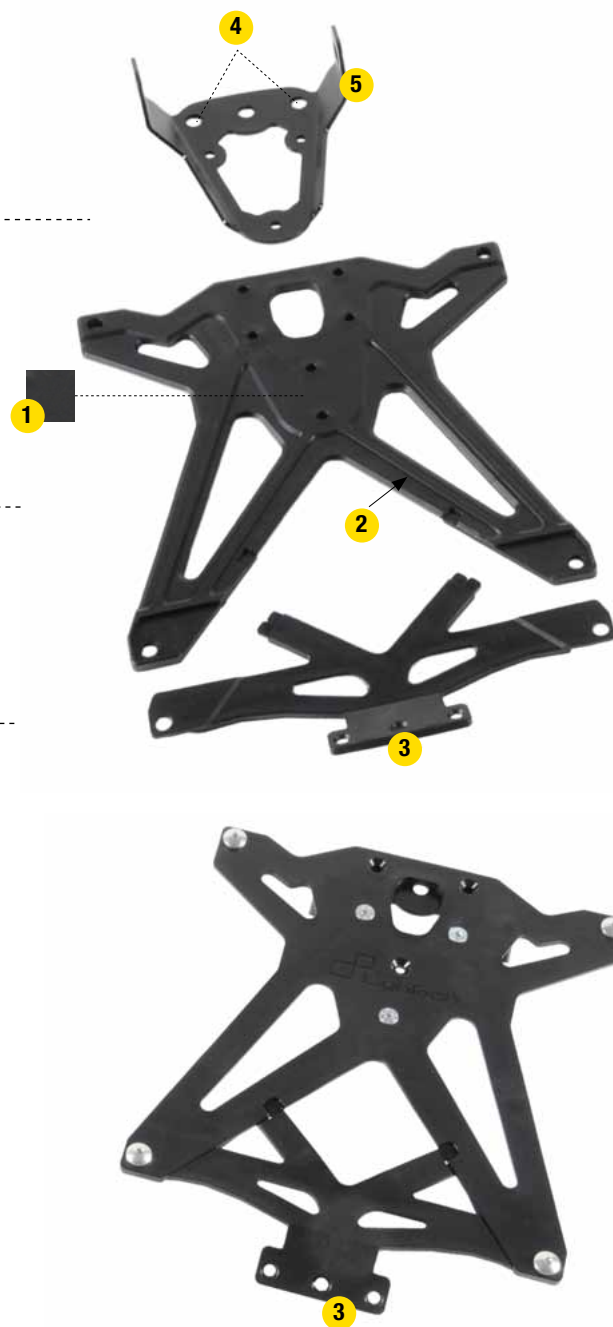

## Nel pieno rispetto del codice della strada

Abiding in full by the street code

**●** Omologated

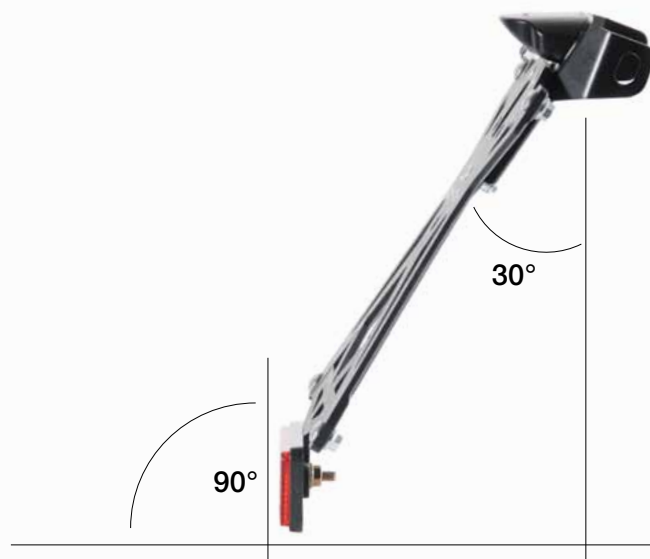





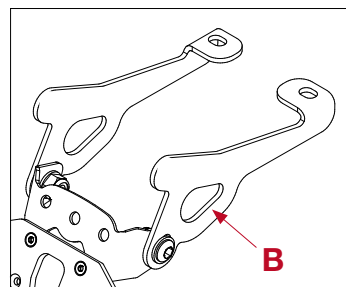
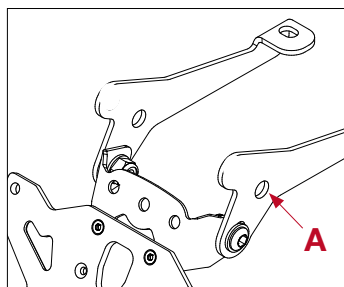



## Porta targa regolabili

Adjustable license plate brackets



- A** = predisposizione montaggio freccia piccola / with hole for little indicator  
**B** = predisposizione montaggio freccia standard / with hole for standard indicator  
**C** = predisposizione montaggio luce targa / with hole for number plate support's light  
**D** = con faro posteriore / with rear stop position light

**N** = DESINENZA NAZIONE DA AGGIUNGERE AL CODICE / ADD THE ABBREVIATION OF NATIONALITY TO THE CODE

IT = Italia  CH = Svizzera  CA = Canada  P = Portogallo  F = Francia   
 USA = Stati Uniti  E = Spagna  SLO = Slovenia  AUS = Australia 

modello - model	anno - years		A	B	C	D	codice - code	N	€
	dal - from	al - to							
<b>APRILIA</b>									
APRILIA RSV 1000	04	05	X		NO		TARAP101	---	
APRILIA RSV4 / Factory	09	11	X		X		TARAP102	---	
APRILIA Tuono	06	09	X		NO		TARAP101	---	
APRILIA Tuono V4	11		X		X		TARAP102	---	
APRILIA Dorsoduro 750	08	11	X	X	X		TARAP103	---	
APRILIA Dorsoduro 1200	11		X	X	X		TARAP104	---	
<b>BENELLI</b>									
BENELLI TNT			X		X		TARBN101	---	
<b>BMW</b>									
BMW S1000RR	09	11	X	X	X		TARBM101	---	
BMW F800R	10	10			NO		TARBM102	---	
BMW R 1200 GS	08	11		X	X		TARBM103	---	
<b>DUCATI</b>									
DUCATI Monster	03	07			X		TARDU101	---	
DUCATI Monster 696	08	11	X		NO	X	TARDU102	---	
DUCATI Monster 796 - 1100	10	11	X		NO	X	TARDU107	---	
DUCATI 749 - 999	02	06			X		TARDU103	---	
DUCATI 848 - 1098 - 1198	07	11	X	X	X		TARDU104	---	
DUCATI Hypermotard 796 -1100	07	11	X		NO	X	TARDU105	---	
DUCATI Multistrada 1200 S	10	11	X	X	X		TARDU108	---	
DUCATI Streetfighter	09	11	X	X	X		TARDU106	---	
<b>GUZZI</b>									
MOTO GUZZI GRISO	06	07	X	X	X		TARGU101	---	
<b>HONDA</b>									
HONDA CBR 600	05	06	X	X	X		TARHO102	---	
HONDA CBR 600	07	11	X		NO	X	TARHO103	---	
HONDA CBR 1000	04	05	X	X	X		TARHO102	---	
HONDA CBR 1000	06	07	X	X	X		TARHO104	---	
HONDA CBR 1000 (no ABS)	08	09	x		NO	X	TARHO105	---	
HONDA CBR 1000	10	11	X		X		TARHO106	---	
HONDA CB 1000 R	08	11	X		X		TARHO107	---	
HONDA HORNET 600	07	10	X		X		TARHO101	---	
HONDA HORNET 600	11		X		X		TARHO108	---	
HONDA CBR 600 F	11		X		X		TARHO108	---	

## Porta targa regolabili

Adjustable license plate brackets

modello - model	anno - years		A	B	C	D	codice - code	N	€
	dal - from	al - to							
<b>KAWASAKI</b>									
KAWASAKI 250R	09	11	X	X	X		TARKA101	---	
KAWASAKI ZX6R	03	04	X	X	X		TARKA102	---	
KAWASAKI ZX6R	05	06	X		X		TARKA103	---	
KAWASAKI ZX6R	07	08	X		NO	X	TARKA104	---	
KAWASAKI ZX6R	09	11	X		X		TARKA105	---	
KAWASAKI ZX10R	04	05	X	X	X		TARKA106	---	
KAWASAKI ZX10 R	06	07			X		TARKA107	---	
KAWASAKI ZX10 R	08	10	X		X		TARKA105	---	
KAWASAKI ZX10 R	11				X		TARKA113	---	
KAWASAKI ER - 6N	06	08	X	X	X		TARKA106	---	
KAWASAKI ER - 6N	09	11	X		X		TARKA108	---	
KAWASAKI Z 750	04	06	X	X	X		TARKA102	---	
KAWASAKI Z 750	07	11	X		X		TARKA109	---	
KAWASAKI Z 1000	03	06	X	X	X		TARKA102	---	
KAWASAKI Z 1000	07	09	X		X		TARKA109	---	
KAWASAKI Z 1000	10	11	X		X		TARKA110	---	
KAWASAKI Z 1000	10	11		X	X		TARKA111	---	
KAWASAKI Z 1000 SX	11			X	X		TARKA114	---	
KAWASAKI Z 1000 SX	11		X		X		TARKA115	---	
KAWASAKI VERSYS	10	11	X	X	X		TARKA112	---	
<b>KTM</b>									
KTM 690 SM / 690 SMR	07	11	X		X		TARKT101	---	
KTM Super Duke 990	07	11	X		X		TARKT102	---	
<b>MORINI</b>									
MORINI CORSARO	06	08	X		X		TARMO101	---	
<b>MV</b>									
MV AGUSTA Brutale	01	10	X		X		TARMV101	---	
MV AGUSTA F4	00	09	X	X	X		TARMV102	---	
MV AGUSTA F4	10	11	X		X		TARMV103	---	
<b>SUZUKI</b>									
SUZUKI GSXR 1000	05	08			X		TARSU101	---	
SUZUKI GSXR 1000	09	11			X		TARSU102	---	
SUZUKI GSXR 600 / 750	06	07			X		TARSU103	---	
SUZUKI GSXR 600 / 750	08	10			X		TARSU104	---	
SUZUKI GSXR 600 / 750	11				X		TARSU109	---	
SUZUKI GSR 600	06	11	X		X		TARSU105	---	
SUZUKI GSR 750	11		X		X		TARSU110	---	
SUZUKI SV 650 / 650S	03	08	X		X		TARSU106	---	
SUZUKI SV 1000	04	06	X		X		TARSU106	---	
SUZUKI B - KING	08	11	X		NO	X	TARSU107	---	
SUZUKI GLADIUS	09	11	X	X	NO	X	TARSU108	---	
<b>TRIUMPH</b>									
TRIUMPH Speed Triple 1050	05	07	X	X	X		TARTR101	---	
TRIUMPH Speed Triple 1050	08	10	X		NO	X	TARTR102	---	
TRIUMPH Street Triple 675	07	11	X		X		TARTR103	---	
TRIUMPH DAYTONA 675	07	11	X	X	X		TARTR104	---	
TRIUMPH Speed Triple 1050	11		X		X		TARTR105	---	
<b>YAMAHA</b>									
YAMAHA YZF - R 125	08	11	X	X	X		TARYA101	---	
YAMAHA R6	06	11	X		X		TARYA102	---	
YAMAHA R6	06	11		X	X		TARYA103	---	
YAMAHA R1	04	08	X		X		TARYA102	---	
YAMAHA R1	04	08		X	X		TARYA103	---	
YAMAHA R1	09	11	X		X		TARYA104	---	
YAMAHA R1	09	11		X	X		TARYA105	---	
YAMAHA Fazer 600 + FZ6	04	11	X		X		TARYA106	---	
YAMAHA Fazer 600 + FZ6	04	11		X	X		TARYA107	---	
YAMAHA XJ6	08	11	X	X	X		TARYA108	---	
YAMAHA FZ1 + FAZER 1000	06	11	X	X	X		TARYA109	---	
YAMAHA FZ8	10	11	X	X	X		TARYA109	---	
YAMAHA MT - 03	06	11	X		NO	X	TARYA110	---	
YAMAHA T - MAX	04	07			X		TARYA111	---	
YAMAHA T - MAX (con sottocodone / with undertail)	08	11			X		TARYA112	---	
YAMAHA T - MAX (senza sottocodone / without undertail)	08	11			X		TARYA113	---	





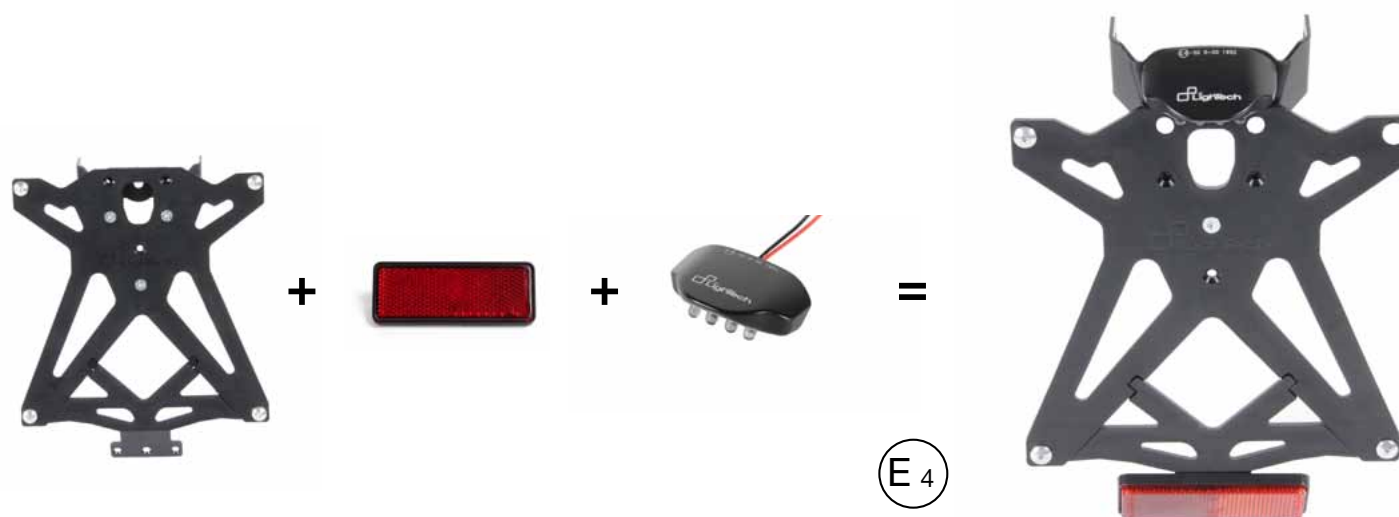



## KIT porta targa regolabili

Adjustable license plate brackets KIT



- A** = predisposizione montaggio freccia piccola / with hole for little indicator  
**B** = predisposizione montaggio freccia standard / with hole for standard indicator  
**C** = con luce targa / with plate support's light  
**D** = con faro posteriore / with rear stop position light

**N** = DESINENZA NAZIONE DA AGGIUNGERE AL CODICE / ADD THE ABBREVIATION OF NATIONALITY TO THE CODE

IT = Italia  CH = Svizzera  CA = Canada  P = Portogallo  F = Francia   
 USA = Stati Uniti  E = Spagna  SLO = Slovenia  AUS = Australia 

modello - model	anno - years		A	B	C	D	codice - code	N	€
	dal - from	al - to							
<b>APRILIA</b>									
APRILIA RSV 1000	04	05	X		NO		KTARAP101	---	
APRILIA RSV4 / Factory	09	11	X		X		KTARAP102	---	
APRILIA Tuono	06	09	X		NO		KTARAP101	---	
APRILIA Tuono V4	11		X		X		KTARAP102	---	
APRILIA Dorsoduro 750	08	11	X	X	X		KTARAP103	---	
APRILIA Dorsoduro 1200	11		X	X	X		KTARAP104	---	
<b>BENELLI</b>									
BENELLI TNT			X		X		KTARBN101	---	
<b>BMW</b>									
BMW S1000RR	09	11	X	X	X		KTARBM101	---	
BMW F800R	10	10			NO		KTARBM102	---	
BMW R 1200 GS	08	11		X	X		KTARBM103		
<b>DUCATI</b>									
DUCATI Monster	03	07			X		KTARDU101	---	
DUCATI Monster 696	08	11	X		NO	X	KTARDU102	---	
DUCATI Monster 796 - 1100	10	11	X		NO	X	KTARDU107	---	
DUCATI 749 - 999	02	06			X		KTARDU103	---	
DUCATI 848 - 1098 - 1198	07	11	X	X	X		KTARDU104	---	
DUCATI Hypermotard 796 -1100	07	11	X		NO	X	KTARDU105	---	
DUCATI Multistrada 1200 S	10	11	X	X	X		KTARDU108	---	
DUCATI Streetfighter	09	11	X	X	X		KTARDU106	---	
<b>GUZZI</b>									
MOTO GUZZI GRISO	06	07	X	X	X		KTARGU101	---	
<b>HONDA</b>									
HONDA CBR 600	05	06	X	X	X		KTARHO102	---	
HONDA CBR 600	07	11	X		NO	X	KTARHO103	---	
HONDA CBR 1000	04	05	X	X	X		KTARHO102	---	
HONDA CBR 1000	06	07	X	X	X		KTARHO104	---	
HONDA CBR 1000 (no ABS)	08	09	x		NO	X	KTARHO105	---	
HONDA CBR 1000	10	11	X		X		KTARHO106	---	
HONDA CB 1000 R	08	11	X		X		KTARHO107	---	
HONDA HORNET 600	07	10	X		X		KTARHO101	---	
HONDA HORNET 600	11		X		X		KTARHO108	---	
HONDA CBR 600 F	11		X		X		KTARHO108	---	

## KIT porta targa regolabili

Adjustable license plate brackets KIT

modello - model	anno - years		A	B	C	D	codice - code	N	€
	dal - from	al - to							
<b>KAWASAKI</b>									
KAWASAKI 250R	09	11	X	X	X		KTARKA101	---	
KAWASAKI ZX6R	03	04	X	X	X		KTARKA102	---	
KAWASAKI ZX6R	05	06	X		X		KTARKA103	---	
KAWASAKI ZX6R	07	08	X		NO	X	KTARKA104	---	
KAWASAKI ZX6R	09	11	X		X		KTARKA105	---	
KAWASAKI ZX10R	04	05	X	X	X		KTARKA106	---	
KAWASAKI ZX10 R	06	07			X		KTARKA107	---	
KAWASAKI ZX10 R	08	10	X		X		KTARKA105	---	
KAWASAKI ZX10 R	11				X		KTARKA113	---	
KAWASAKI ER - 6N	06	08	X	X	X		KTARKA106	---	
KAWASAKI ER - 6N	09	11	X		X		KTARKA108	---	
KAWASAKI Z 750	04	06	X	X	X		KTARKA102	---	
KAWASAKI Z 750	07	11	X		X		KTARKA109	---	
KAWASAKI Z 1000	03	06	X	X	X		KTARKA102	---	
KAWASAKI Z 1000	07	09	X		X		KTARKA109	---	
KAWASAKI Z 1000	10	11	X		X		KTARKA110	---	
KAWASAKI Z 1000	10	11		X	X		KTARKA111	---	
KAWASAKI Z 1000 SX	11			X	X		KTARKA114	---	
KAWASAKI Z 1000 SX	11		X		X		KTARKA115	---	
KAWASAKI VERSYS	10	11	X	X	X		KTARKA112	---	
<b>KTM</b>									
KTM 690 SM / 690 SMR	07	11	X		X		KTARKT101	---	
KTM Super Duke 990	07	11	X		X		KTARKT102	---	
<b>MORINI</b>									
MORINI CORSARO	06	08	X		X		KTARMO101	---	
<b>MV</b>									
MV AGUSTA Brutale	01	10	X		X		KTARMV101	---	
MV AGUSTA F4	00	09	X	X	X		KTARMV102	---	
MV AGUSTA F4	10	11	X		X		KTARMV103	---	
<b>SUZUKI</b>									
SUZUKI GSXR 1000	05	08			X		KTARSU101	---	
SUZUKI GSXR 1000	09	11			X		KTARSU102	---	
SUZUKI GSXR 600 / 750	06	07			X		KTARSU103	---	
SUZUKI GSXR 600 / 750	08	10			X		KTARSU104	---	
SUZUKI GSXR 600 / 750	11				X		KTARSU109	---	
SUZUKI GSR 600	06	11	X		X		KTARSU105	---	
SUZUKI GSR 750	11		X		X		KTARSU110	---	
SUZUKI SV 650 / 650S	03	08	X		X		KTARSU106	---	
SUZUKI SV 1000	04	06	X		X		KTARSU106	---	
SUZUKI B - KING	08	11	X		NO	X	KTARSU107	---	
SUZUKI GLADIUS	09	11	X	X	NO	X	KTARSU108	---	
<b>TRIUMPH</b>									
TRIUMPH Speed Triple 1050	05	07	X	X	X		KTARTR101	---	
TRIUMPH Speed Triple 1050	08	10	X		NO	X	KTARTR102	---	
TRIUMPH Street Triple 675	07	11	X		X		KTARTR103	---	
TRIUMPH DAYTONA 675	07	11	X	X	X		KTARTR104	---	
TRIUMPH Speed Triple 1050	11		X		X		KTARTR105	---	
<b>YAMAHA</b>									
YAMAHA YZF - R 125	08	11	X	X	X		KTARYA101	---	
YAMAHA R6	06	11	X		X		KTARYA102	---	
YAMAHA R6	06	11		X	X		KTARYA103	---	
YAMAHA R1	04	08	X		X		KTARYA102	---	
YAMAHA R1	04	08		X	X		KTARYA103	---	
YAMAHA R1	09	11	X		X		KTARYA104	---	
YAMAHA R1	09	11		X	X		KTARYA105	---	
YAMAHA Fazer 600 + FZ6	04	11	X		X		KTARYA106	---	
YAMAHA Fazer 600 + FZ6	04	11		X	X		KTARYA107	---	
YAMAHA XJ6	08	11	X	X	X		KTARYA108	---	
YAMAHA FZ1 + FAZER 1000	06	11	X	X	X		KTARYA109	---	
YAMAHA FZ8	10	11	X	X	X		KTARYA109	---	
YAMAHA MT - 03	06	11	X		NO	X	KTARYA110	---	
YAMAHA T - MAX	04	07			X		KTARYA111	---	
YAMAHA T - MAX (con sottocodone / with undertail)	08	11			X		KTARYA112	---	
YAMAHA T - MAX (senza sottocodone / without undertail)	08	11			X		KTARYA113	---	

Fanalino targa - License plate light



codice-code: LT002  
con copri faro - with cover

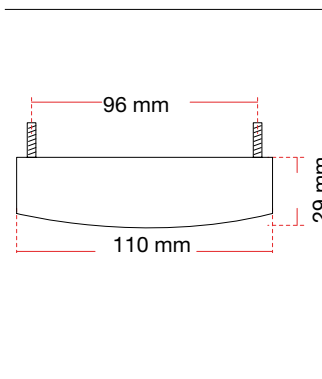

codice-code: LT003  
senza copri faro - without cover



codice-code: PTLA



OMOLOGATED



codice-code: PTLA2

Indicatori di direzione a led - Led turn signals



codice-code: FRE02NER  
nero - black

a coppia - for pair



codice-code: FRE02ROS  
rosso - red

a coppia - for pair



OMOLOGATED E6

codice-code: FRE906NER  
nero - black

a coppia - for pair



LED 10 W		
SUZUKI	06	>
KAWASAKI	07	09
DUCATI	01	>
APRILIA		05
KTM		



LED 21 W		
HONDA	07	>
TRIUMPH		
APRILIA	06	>
HARLEY D.		



LED 10 W		
BMW	06	>
KAWASAKI	10	>
YAMAHA	07	>
DUCATI		00
LED 21 W		
SUZUKI	06	>

codice-code: IN 817

Kit resistenza - Kit resistance

a coppia - for pair

codice-code: IN 818

Kit resistenza - Kit resistance

a coppia - for pair

codice-code: IN 820

Kit resistenza - Kit resistance

a coppia - for pair



Regola l'intensità elettrica allo scopo di permettere alle frecce after market di funzionare normalmente. Adatto alle moto oltre 400 cm<sup>3</sup>.  
Regulate electric intensity so that after market indicators works normally. Fit on bikes more than 400 cc

codice-code: IN 809

Kit resistenza  
Kit resistance

a coppia - for pair



Regola il lampeggio elettronicamente, funziona con tutti i tipi di frecce. Fornita in blister.  
Regulate blinker intensity, works with all kind of indicators. Blister packing.

codice-code: IN 810

Centralina elettrica lampeggianti  
Indicators electrical box

a coppia - for pair



Connettori special - Special connector

mod.	codice-code	€
		a coppia - for pair
HONDA	IN 912	
YAMAHA	IN 913	
SUZUKI	IN 914	
KAWASAKI	IN 915	

## Piastrine frecce - Plate for direction indicators



codice-code: PFY

per 4 pezzi  
for 4 pieces



codice-code: PFK

per 4 pezzi  
for 4 pieces



codice-code: PFH2

per 4 pezzi  
for 4 pieces



codice-code: PFS

per 4 pezzi  
for 4 pieces

## Catadiottro con staffa di supporto - Retroreflector with support bracket

E 6

OMOLOGATED



codice - code	nazione - nation	€
		a pezzo - for piece
KAT01	Italy - Spain - Portugal - Canada - USA - Australia	
KAT02	Switzerland	
KAT03	Slovenia	



# PROTEZIONI PROTECTIONS



## Protezioni telaio

Frame sliders

**PATENTED**



Boccola per oscillazione in magnesio  
Magnesium bushing for oscillation

Guscio in Nylon  
Nylon shell

Gommino antishock in TPE durezza 60 Shore  
Antishock rubber made of TPE - hardness 60 Shore

Fondo in magnesio  
Magnesium bottom

DX = destro / right SX = sinistra / left Ø = foro interno boccola / internal bush hole

Colori disponibili: nero. Available colours: black

modello - model	anno - years		foro carena drill fairing	Ø	codice - code	€
	dal - from	al - to				
<b>APRILIA</b>						
APRILIA SHIVER 750	07	11	NO	10	STEAP101	
APRILIA TUONO V4	11		NO	10	STEAP103	
APRILIA DORSODURO	08	11	NO	10	STEAP101	
APRILIA RSV4 + factory	09	11	NO	-	STEAP102	
<b>BMW</b>						
BMW S1000RR	09	11	NO	10	STEBM101	
BMW F800R	09	11	NO	-	STEBM102	
BMW R 1200 GS	08	11	NO	-	STEBM103	
<b>DUCATI</b>						
DUCATI HYPERMOTARD 1100	07	11	NO	10	STEDU101	
DUCATI MONSTER 696 - 796	08	11	NO	10	STEDU102	
DUCATI STREETFIGHTER	09	11	NO	10	STEDU103	
<b>HONDA</b>						
HONDA CBR 600 RR	03	06	DX / SX	12	STEOH0101	
HONDA CBR 600 RR	07	08	NO	10	STEOH0102	
HONDA CBR 600 RR	09	11	DX / SX	12	STEOH0103	
HONDA HORNET 600	03	06	NO	10	STEOH0104	
HONDA HORNET 600	07	11	NO	12	STEOH0105	
HONDA HORNET 900	02	06	NO	10	STEOH0106	
HONDA CBR 1000	04	05	NO	10	STEOH0107	
HONDA CBR 1000	06	07	NO	10	STEOH0108	
HONDA CBR 1000	08	11	DX / SX	12	STEOH0109	
HONDA CBF 1000	06	07	NO	12	STEOH0110	
HONDA CB 1000 R	08	11	NO	12	STEOH0111	
HONDA VFR 800	02	06	NO	10	STEOH0112	
<b>KAWASAKI</b>						
KAWASAKI 250R	09	11	NO	10	STEKA101	
KAWASAKI ZX6R	05	06	DX / SX	10	STEKA102	
KAWASAKI ZX6R	07	08	NO	10	STEKA103	
KAWASAKI ZX10R	08	10	SX	10	STEKA104	
KAWASAKI ZX10R	11	11	SX	10	STEKA110	
KAWASAKI Z750	04	06	NO	10	STEKA105	
KAWASAKI Z750	07	10	NO	10	STEKA106	
KAWASAKI Z1000	03	06	NO	10	STEKA105	
KAWASAKI Z1000	07	09	NO	10	STEKA106	
KAWASAKI Z1000	10	11	NO	10	STEKA107	
KAWASAKI ER - 6N	06	08	NO	10	STEKA108	
KAWASAKI ER - 6N	09	11	NO	10	STEKA109	

modello - model	anno - years		foro carena drill fairing	Ø	codice - code	€
	dal - from	al - to				
<b>KTM</b>						
KTM SUPER DUKE	05	06	NO	10	STEKT101	
KTM SUPER DUKE 990	07	11	NO	10	STEKT102	
<b>MV</b>						
MV BRUTALE 750 / 1000	01	11	NO	13	STEMV101	
<b>SUZUKI</b>						
SUZUKI GSXR 600 / 750	06	07	NO	10	STESU101	
SUZUKI GSXR 600 / 750	08	10	NO	10	STESU102	
SUZUKI GSXR 600 / 750	11		NO	10	STESU110	
SUZUKI GSXR 1000	03	04	NO	10	STESU103	
SUZUKI GSXR 1000	05	06	NO	10	STESU104	
SUZUKI GSXR 1000	07	08	NO	10	STESU105	
SUZUKI GSXR 1000	09	10	NO	10	STESU106	
SUZUKI SV 650 / 650S	04	08	NO	10	STESU107	
SUZUKI SV 1000	03	06	NO	10	STESU107	
SUZUKI GSR 600	06	11	NO	10	STESU108	
SUZUKI GSR 750	11		NO	10	STESU111	
SUZUKI Gladius 650	09	11	NO	10	STESU109	
<b>TRIUMPH</b>						
TRIUMPH Speed Triple 1050	05	07	NO	12	STETR101	
TRIUMPH Speed Triple 1050	08	10	NO	12	STETR102	
TRIUMPH Speed Triple 1050	11		NO	12	STETR104	
TRIUMPH Street Triple 675	07	11	NO	10	STETR103	
<b>YAMAHA</b>						
YAMAHA R1	04	06	NO	10	STEYA101	
YAMAHA R1	07	08	NO	10	STEYA102	
YAMAHA R6	06	07	NO	10	STEYA103	
YAMAHA R6	08	11	NO	10	STEYA104	
YAMAHA FAZER 600 + FZ6	04	11	NO	10	STEYA105	
YAMAHA FZ8	10	11	NO	10	STEYA106	
YAMAHA FZ1	06	11	NO	10	STEYA106	
YAMAHA XJ6	09	11	NO	10	STEYA107	
YAMAHA MT-03	06	11	NO	10	STEYA108	

APRILIA RSV4



BMW F800R



## Ricambi protezioni telaio

Frame slider spare parts

Colori disponibili: bianco, rosso, verde, nero, indaco  
Available colours: white, red, green, black, indigo

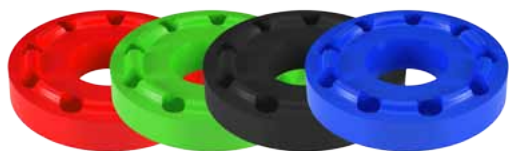

modello - model	Ø	codice - code	€ a coppia - for pair
GOMMINO SHOCK ABSORBER SHOCK ABSORBER RUBBER	55mm	STE001	
	50mm	<b>NEW</b> RSTE101	

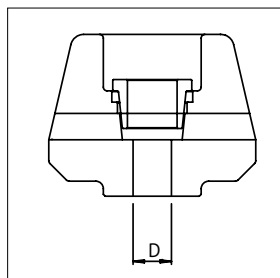

PTRIC

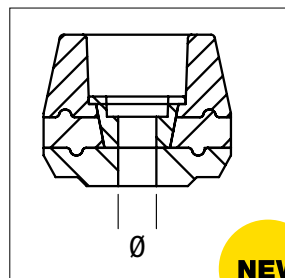

RSTE

**NEW**

modello - model	codice - code	€ a pezzo - for piece
BOCCOLE Ø10 - BUSHES Ø10	PTRIC10	
BOCCOLE Ø12 - BUSHES Ø12	PTRIC12	
BOCCOLE Ø13 - BUSHES Ø13	PTRIC13	
BOCCOLE Ø10 - BUSHES Ø10	<b>NEW</b> RSTE110	
BOCCOLE Ø12 - BUSHES Ø12	<b>NEW</b> RSTE112	
BOCCOLE Ø13 - BUSHES Ø13	<b>NEW</b> RSTE113	

## Protezioni perni ruota

Wheel axle sliders



Colori disponibili: rosso, titanio - Available colours: red, titanium.

modello - model	anno - years		Ø				codice - code	€ 4 pz/pcs
	dal - from	al - to	ant. dx - right front	ant. sx - left front	post. dx - right rear	post. sx - left rear		
<b>APRILIA</b>								
APRILIA SHIVER 750	07	11	19	23	19	19	ARAP101	
APRILIA RSV4 + Factory	09	11	19	23	19	19	ARAP101	
APRILIA TUONO V4	11		19	23	19	19	ARAP101	
<b>BMW</b>								
BMW S1000RR	09	11	24	15,5	16	23	ARBM101	
<b>KAWASAKI</b>								
KAWASAKI ZX6R	07	11	22	22	19,5	14,5	ARKA101	
KAWASAKI ZX10R	06	07	19,3	15,6	14,6	10,6	ARKA102	
KAWASAKI ZX10R	08	10	22	22	14	10	ARKA103	
KAWASAKI ZX10R	11		22	22	19,5	14,5	ARKA101	
<b>HONDA</b>								
HONDA CBR 600 R	07	11	M14 x 1,50	17	14	19,6	ARHO101	
HONDA CBR 1000 R	08	11	M18 x 1,50	22	14	19,3	ARHO102	
<b>SUZUKI</b>								
SUZUKI GSXR 600 / 750	06	10	M18 x 1,50	24	16,5	23,2	ARSU101	
SUZUKI GSXR 600 / 750	11		19	11,8	19	14	ARSU102	
SUZUKI GSXR 1000	07	11	M18 x 1,50	24	16,5	23,2	ARSU101	
<b>YAMAHA</b>								
YAMAHA R6	06	11	19	M14 x 1,5	16	23,5	ARYA101	
YAMAHA R1	07	11	19	M14 x 1,5	16	23,5	ARYA101	



**VITERIA**  
SCREWS











## Viti special in ergal 7075 - 7075 ergal special screws

Viti special - standard - special screws - standard

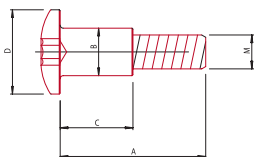

936

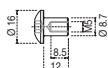

1011

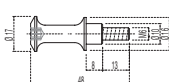

1012

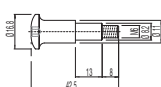

1014

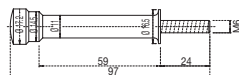

1024

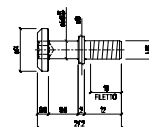

Colori disponibili: indaco, rosso, oro, nero, blu, silver. Available colours: indigo, red, gold, black, blue, silver.

codice - code	M	A	B	C	D	€
930	8	38,5	12,4	19	22	
931	10	49	12,4	18,5	22	
931B	10	38	12,4	19	22	
932	4	12			9	
933	6	19,5	7,5	3,5	14	
934	10	56,5	11,9	22,5	19	
935	8	38,5	11,9	22,5	19	
936	5	12	8,7	12	16	
940	6	17,4	7,9	8,4	17	
941	5	15	7,4	7,5	12	
950	6	20			10	
951	8	31	10	6	17	
952	8	41	9,9	6	16	
953	8	20	9,9	5	17	
954	6	30	6	9	10	
955	6	23,5	9,9	11	20	
956	6	15			10	
960	8	33	9,9	11	15	
961	10	25	9,9	4	15	
962	5	16,5	8,1	3,7	14	

codice - code	M	A	B	C	D	€
963	6	20	7,9	9,5	18	
964	7	17,5	10,9	5,5	24	
965	6	15	7,9	3	14	
970	4	21,5	4	5,5	10	
971	4	7			10	
972	6	11,5	8,2	3,75	14	
974	6	15	9,85	5	22	
976	6	19	7,9	8	14	
977	6	30,5	8	23,5	14	
978	6	15	7,9	6	14	
979	6	13	6,9	4,4	14	
980	6	14	7,9	3,8	14	
981	5	15,6	7,9	2,6	14	
982	6	16	8,4	3,5	14	
983	6	15	7,9	6	17	
984	6	15	8,9	4	14	
991	6	30	6	11	12	
992	6	11	9,9	3,5	17	
993	5	10	8,9	3	14	
994	6	14,5	9,4	6	17	
995	6	14,5	11,9	3,5	17	
997	6	15	8,9	5	14	
998	6	15	9,9	3,5	17	
999	5	15	7	2,5	11,5	
1000	6	15	9	2	14	
1001	5	20,5	7	13,5	12	
1002	5	20,5	6,9	2,5	12	
1003	6	11	8,2	4	14	
1004	6	14	7,9	5,5	14	
1005	6	15	9,8	5,5	22	
1006	10	40	10	5	16	
1007	6	20	6	1,5	30	
1008	6	25,5	8	13,5	17	
1009	5	25			9	
1011	6	21	10	8	17	
1012	6	21	8,25	13	17	
1013	6	25,5	8	10,5	24	
1014	modifica chiusura sella triumph - special screw to open and close the triumph seat					
1015	5	16	8,2	8	14	
1016	6	16,5	8,5	3,5	17	
1018	6	16,5	8,2	5	12	
1019	6	20	9,8	8,6	17	
1020	5	17	8,2	5,8	14	
1021	6	20	8,7	9,2	14	
1022	5	12,8	8,1	3,7	14	
1023	5	11	8	2,6	14	
1024	6	-	-	-	-	

## Viti forate - Drilled screws



Colori disponibili: indaco, rosso, oro, nero, blu, silver.  
Available colours: indigo, red, gold, black, blue, silver.

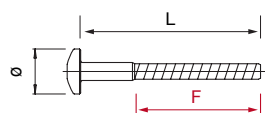

	lunghezza - length	Ø testa - head	codice - code	€
M5	15	12	FORM515	
M5	20	12	FORM520	
M6	15	17	FORM615	
M6	20	17	FORM620	
M6	25	17	FORM625	
M6	30	17	FORM630	
M8	20	22	FORM820	
M8	30	22	FORM830	
M8	40	22	FORM840	
M8	45	22	FORM845	

## Autofilettanti ergal 7075 - 7075 ergal self tapping screws



Colori disponibili: indaco, rosso, oro, nero, blu, silver.  
Available colours: indigo, red, gold, black, blue, silver.

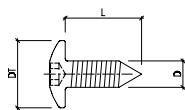

## PAC 2

Ø	lunghezza - length	Ø testa - head	codice - code	€
4,5	13	10	PAC24513	
4,5	16	10	PAC24516	
4,9	13	10	PAC24913	
4,9	16	10	PAC24916	
5,5	16	10	PAC25516	
5,5	19	10	PAC25519	



Colori disponibili: indaco, rosso, oro, nero, blu, silver.  
Available colours: indigo, red, gold, black, blue, silver.

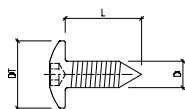

## PAC 3

Ø	lunghezza - length	Ø testa - head	codice - code	€
4,5	13	14	PAC34513	
4,5	16	14	PAC34516	
4,9	13	14	PAC34913	
4,9	16	14	PAC34916	
5,5	16	14	PAC35516	
5,5	19	14	PAC35519	

### Ganci rapidi in ergal 7075 - 7075 ergal quick fairing fasteners



Colori disponibili: indaco, rosso, oro, nero, blu, silver.  
Available colours: indigo, red, gold, black, blue, silver.

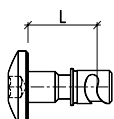

misura - measure	codice - code	€
11 mm	GR11	
12 mm	GR12	
14 mm	GR14	
16 mm	GR16	
22 mm	GR22	

### Ganci rapidi in ferro - Iron quick fairing fasteners

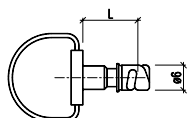

misura - measure	codice - code	€
11 mm	GRFE11	
12 mm	GRFE12	
14 mm	GRFE14	

### Ricettacoli - Receptacle



codice - code	€
RIC	

### Cappelletto valvola ruota - Wheel valve cap



Colori disponibili: indaco, rosso, oro, nero, blu, silver.  
Available colours: indigo, red, gold, black, blue, silver.

codice - code	€
VAL	

## Dadi

## Nuts



ERGAL

0011	M4	M5	M6	M8	M10 x 1,25	M10 x 1,5	M12 x 1,25
€							



Colori disponibili: indaco, rosso, oro, nero, blu, silver.  
Available colours: indigo, red, gold, black, blue, silver.



ERGAL

0015	M4	M5	M6	M8	M10 x 1,25	M10 x 1,5	M12 x 1,25
€					-	-	-



Colori disponibili: indaco, rosso, oro, nero, blu, silver.  
Available colours: indigo, red, gold, black, blue, silver.



ERGAL

0016	M4	M5	M6	M8	M10 x 1,25	M10 x 1,5	M12 x 1,25
€	-				-	-	-



Colori disponibili: indaco, rosso, oro, nero, blu, silver.  
Available colours: indigo, red, gold, black, blue, silver.



TITANIO - TITANIUM

T0015	M4	M5	M6	M8	M10 x 1,25	M10 x 1,5	M12 x 1,25
€							



misura - measure	Ø est. Ø ext.	spessore - thickness	codice - code		€
			ERGAL	TITANIO - TITANIUM	
M4	9	0,8	RM4	RM4T	
M5	10	1,5	RM5	RM5T	
M6	12	1,6	RM6	RM6T	
M8	17	1,6	RM8	RM8T	
M10	21	2	RM10	RM10T	

Colori disponibili: indaco, rosso, oro, nero, blu, silver. Available Colours: indigo, red, gold, black, blue, silver.

### RONDELLE SPECIALI - SPECIAL WASHERS



misura - measure	Ø est. Ø ext.	spessore - thickness	codice - code		€
			ERGAL	TITANIO - TITANIUM	
M4	16	1,6	RSM4	RSM4T	
M5	17	1,6	RSM5A	RSM5AT	
M5	21	1,6	RSM5B	RSM5BT	
M6	17	1,6	RSM6A	RSM6AT	
M6	21	1,6	RSM6B	RSM6BT	
M6	30	2	RSM6C	RSM6CT	
M8	21	2	RSM8A	RSM8AT	
M8	30	2	RSM8B	RSM8BT	
M10	30	2	RSM10	RSM10T	

Colori disponibili: indaco, rosso, oro, nero, blu, silver. Available Colours: indigo, red, gold, black, blue, silver.

### RONDELLE P.E.B.D. - WASHERS P.E.B.D.



misura - measure	Ø est. Ø ext.	spessore - thickness	codice - code		€
			ERGAL	TITANIO - TITANIUM	
M4	10	0,5	RPM4	-	-
M5	12	0,5	RPM5	-	-
M6	14	0,5	RPM6	-	-
M8	16	0,5	RPM8	-	-

### RONDELLE INCASSATE CONICHE - WASHERS FOR HEAD



misura - measure	Ø est. Ø ext.	spessore - thickness	codice - code		€
			ERGAL	TITANIO - TITANIUM	
M5	15	4	RCM5	-	-
M6	22	4	RCM6	-	-
M8	25	4	RCM8	-	-

Colori disponibili: indaco, rosso, oro, nero, blu, silver. Available Colours: indigo, red, gold, black, blue, silver.

### PIATTELLI - WASHERS



modello - model	codice - code	€
KAWASAKI	PIAK	



modello - model	codice - code	€
DUCATI	PIAD	



Colori disponibili: indaco, rosso, oro, nero, blu, silver. Available Colours: indigo, red, gold, black, blue, silver.

## Viti dischi freno in titanio grado 5

Screws for brake disk in titanium 5 degree



I modelli di moto citati sono indicativi,  
pertanto si consiglia di verificare le misure delle viti.

The motorbikes mentioned can be not correct,  
please control the measures.

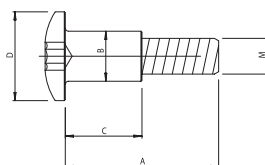

moto - bike	M	A	B	C	D	codice - code	€
							a pezzo - for piece
KAWASAKI	8	31	10	5	18	VIT K	
SUZUKI	8	33	10	10	16	VIT S	
SUZUKI	8	21	9,9	6	16	VIT S2	
DUCATI	8	15	—	—	13	VIT D1	
DUCATI	8	20	—	—	13	VIT D2	
HONDA ANT. / front	6	20	—	—	15	VIT H1	
HONDA POST. / rear	8	23	10	5	16	VIT H2	
HONDA CR. ANT. / front	8	20	—	—	12	VIT H3	
YAMAHA ANT. / front	6	21	8	6	14	VIT Y	
YAMAHA POST. / rear	8	20	9,8	4,5	16	VIT Y2	

## Tappi telaio

Frame cups



Colori disponibili: rosso, oro, nero, silver. Available colours: red, gold, black, silver.

codice - code	Ø interno - inside	Ø esterno - outside	€
			a pezzo - for piece
CFT2026	20 mm	26 mm	
CFT2228	22 mm	28 mm	
CFT2530	25 mm	30 mm	
CFT2331	23 mm	31 mm	





**KIT VITI**  
SCREW KIT

## Kit viti

## Screw kit

modello - model	anno - years		quantità - pieces	codice - code	€
	dal - from	al - to			
<b>APRILIA</b>					
<b>APRILIA TUONO V4</b>	11				
MOTORE / engine			34	1AT M	
TELAIO / frame			28	1AT T	
CARENA / fairing			42	1AT C	
<b>APRILIA RSV 1000</b>	04	04			
MOTORE / engine			55	4A1 M	
TELAIO / frame			33	4A1 T	
CARENA / fairing			57	4A1 C	
GANCI RAPIDI /quick fairing fasteners			10	4A1 GR	
<b>APRILIA RSV 1000 R</b>	05	08			
MOTORE / engine			56	5A1 M	
TELAIO / frame			33	5A1 T	
CARENA / fairing			67	5A1 C	
GANCI RAPIDI /quick fairing fasteners			10	5A1 GR	
<b>APRILIA RSV 4 R+ Factory + APRC</b>	09	11			
MOTORE / engine			30	9A4 M	
TELAIO / frame			22	9A4 T	
CARENA / fairing			44	9A4 C	
<b>APRILIA DORSODURO 750</b>	08	11			
MOTORE / engine			24	9AD M	
TELAIO / frame			29	9AD T	
CARENA / fairing			31	9AD C	
<b>APRILIA DORSODURO 1200</b>	11				
MOTORE / engine			26	1AD M	
TELAIO / frame			25	1AD T	
CARENA / fairing			36	1AD C	
<b>APRILIA SHIVER</b>	07	11			
MOTORE / engine			38	7A7 M	
TELAIO / frame			27	7A7 T	
CARENA / fairing			42	7A7 C	
<b>APRILIA TUONO</b>	03	05			
MOTORE / engine			31	3A1 M	
TELAIO / frame			30	3A1 T	
CARENA / fairing			73	3A1 C	
<b>BMW</b>					
<b>BMW S1000 RR</b>	09	11			
MOTORE / engine			38	0B1 M	
TELAIO / frame			23	0B1 T	
CARENA / fairing			66	0B1 C	
<b>BMW F800 R</b>	10	11			
MOTORE / engine			39	0B8 M	
TELAIO / frame			25	0B8 T	
CARENA / fairing			36	0B8 C	
<b>BMW R 1200 GS</b>	08	11			
CARENA / fairing			40	1BG C	
<b>BENELLI</b>					
<b>TNT</b>	04				
MOTORE / engine			26	4B1 M	
TELAIO / frame			33	4B1 T	
CARENA / fairing			43	4B1 C	

modello - model	anno - years		quantità - pieces	codice - code	€
	dal - from	al - to			
<b>DUCATI</b>					
<b>DUCATI MONSTER 900</b>	99	01			
MOTORE / engine			68	KD9 M	
TELAIO / frame			47	KD9 T	
CARENA / fairing			26	KD9 C	
PEDANE/footrests			8	KD9 P	
<b>DUCATI MONSTER 600 / 750</b>	99	01			
MOTORE / engine			53	KD699 M	
TELAIO / frame			43	KD699 T	
CARENA / fairing			26	KD699 C	
PEDANE/footrests			8	KD699 P	
<b>DUCATI MONSTER DARK IE 620</b>	02	07			
MOTORE / engine			54	3DD M	
TELAIO / frame			48	3DD T	
CARENA / fairing			25	3DD C	
<b>DUCATI MONSTER S4R</b>	03	04			
MOTORE / engine			65	3DS M	
TELAIO / frame			35	3DS T	
CARENA / fairing			48	3DS C	
<b>DUCATI MONSTER 696</b>	08	11			
MOTORE / engine			42	8D6 M	
TELAIO / frame			14	8D6 T	
CARENA / fairing			47	8D6 C	
<b>DUCATI 748 - 916 - 996</b>	96	01			
MOTORE / engine			81	KD7 M	
TELAIO / frame			93	KD7 T	
CARENA / fairing			29	KD7 C	
GANCI RAPIDI /quick fairing fasteners			10	KD7 GR	
<b>DUCATI 749 -999</b>	02	06			
MOTORE / engine			48	2D9 M	
TELAIO / frame			33	2D9 T	
CARENA / fairing			55	2D9 C	
GANCI RAPIDI /quick fairing fasteners			9	2D9 GR	
<b>DUCATI DS 1000 MULTISTRADA</b>	03	09			
MOTORE / engine			57	3D1 M	
TELAIO / frame			25	3D1 T	
CARENA / fairing			51	3D1 C	
<b>DUCATI DS 1200 MULTISTRADA</b>	10	11			
MOTORE / engine			34	0D1 M	
TELAIO / frame			23	0D1 T	
CARENA / fairing			79	0D1 C	
<b>DUCATI 1098 - 1198</b>	07	11			
MOTORE / engine			26	7D1M	
TELAIO / frame			20	7D1 T	
CARENA / fairing			73	7D1 C	
<b>DUCATI 848</b>	08	11			
MOTORE / engine			24	8D8 M	
TELAIO / frame			16	8D8 T	
CARENA / fairing			77	8D8 C	
<b>DUCATI HYPERMOTARD 1100</b>	07	11			
MOTORE / engine			34	7DM M	
TELAIO / frame			24	7DM T	
CARENA / fairing			31	7DM C	
<b>DUCATI STREETFIGHTER</b>	09	11			
MOTORE / engine			47	9DS M	
TELAIO / frame			13	9DS T	
CARENA / fairing			70	9DS C	

## Kit viti

## Screw kit

modello - model	anno - years		quantità - pieces	codice - code	€
	dal - from	al - to			
<b>HONDA</b>					
<b>HONDA HORNET 600</b>	03	06			
MOTORE / engine			41	2H6 M	
TELAIO / frame			30	2H6 T	
CARENA / fairing			45	2H6 C	
<b>HONDA HORNET 600</b>	07	10			
MOTORE / engine			26	7HH M	
TELAIO / frame			27	7HH T	
CARENA / fairing			34	7HH C	
<b>HONDA HORNET 600</b>	11				
MOTORE / engine			26	1HH M	
TELAIO / frame			25	1HH T	
CARENA / fairing			30	1HH C	
<b>HONDA CBR 600 RR</b>	03	04			
MOTORE / engine			35	3H6 M	
TELAIO / frame			23	3H6 T	
CARENA / fairing			58	3H6 C	
<b>HONDA CBR 600 RR</b>	05	06			
MOTORE / engine			35	5H6 M	
TELAIO / frame			25	5H6 T	
CARENA / fairing			59	5H6 C	
<b>HONDA CBR 600 RR</b>	07	08			
MOTORE / engine			25	7H6 M	
TELAIO / frame			27	7H6 T	
CARENA / fairing			59	7H6 C	
<b>HONDA CBR 600 RR</b>	09	10			
TELAIO / frame			30	9HC T	
CARENA / fairing			63	9HC C	
<b>HONDA CBR 600 F</b>	11				
MOTORE / engine			21	1H6 M	
TELAIO / frame			25	1H6 T	
CARENA / fairing			35	1H6 C	
<b>HONDA CBR RR 954</b>	02	03			
MOTORE / engine			23	2H9 M	
TELAIO / frame			24	2H9 T	
CARENA / fairing			64	2H9 C	
<b>HONDA CBR 1000 RR</b>	04	05			
MOTORE / engine			30	4H1 M	
TELAIO / frame			24	4H1 T	
CARENA / fairing			75	4H1 C	
<b>HONDA CBR 1000 RR</b>	06	07			
MOTORE / engine			30	6H1 M	
TELAIO / frame			24	6H1 T	
CARENA / fairing			68	6H1 C	
<b>HONDA CBR 1000 RR</b>	08	10			
MOTORE / engine			26	8H1 M	
TELAIO / frame			26	8H1 T	
CARENA / fairing			43	8H1 C	
<b>HONDA CB 1000 R</b>	08	10			
MOTORE / engine			25	8HB M	
TELAIO / frame			32	8HB T	
CARENA / fairing			31	8HB C	
<b>HONDA CRF 450</b>	05	07			
MOTORE / engine			37	5H4 M	
TELAIO / frame			17	5H4 T	
CARENA / fairing			25	5H4 C	

modello - model	anno - years		quantità - pieces	codice - code	€
	dal - from	al - to			
<b>HONDA CRF 450</b>	08	09			
MOTORE / engine			37	8H4 M	
TELAIO / frame			17	8H4 T	
CARENA / fairing			27	8H4 C	
<b>HONDA CRF 450</b>	10	11			
MOTORE / engine			39	0H4M	
TELAIO / frame			6	0H4T	
CARENA / fairing			38	0H4C	
<b>HUSQUARNA</b>					
<b>HUSQUARNA TE-TC-SMR 250-450-510</b>	06				
MOTORE / engine			24	5Q6 M	
TELAIO / frame			20	5Q6 T	
CARENA / fairing			29	5Q6 C	
<b>KAWASAKI</b>					
<b>KAWASAKI 250R</b>	09	11			
MOTORE / engine			12	9K2 M	
TELAIO / frame			19	9K2 T	
CARENA / fairing			52	9K2 C	
<b>KAWASAKI ZX6R</b>	03	04			
MOTORE / engine			34	3K6 M	
TELAIO / frame			32	3K6 T	
CARENA / fairing			65	3K6 C	
<b>KAWASAKI ZX6R</b>	05	06			
MOTORE / engine			34	5K6 M	
TELAIO / frame			32	5K6 T	
CARENA / fairing			66	5K6 C	
<b>KAWASAKI ZX6R</b>	07	08			
MOTORE / engine			37	7K6 M	
TELAIO / frame			26	7K6 T	
CARENA / fairing			64	7K6 C	
<b>KAWASAKI ZX6R</b>	09	11			
MOTORE / engine			37	9K6 M	
TELAIO / frame			26	9K6 T	
CARENA / fairing			58	9K6 C	
<b>KAWASAKI Z 750</b>	04	06			
MOTORE / engine			32	4K7 M	
TELAIO / frame			31	4K7 T	
CARENA / fairing			31	4K7 C	
<b>KAWASAKI Z 750</b>	07	11			
MOTORE / engine			32	7K7 M	
TELAIO / frame			43	7K7 T	
CARENA / fairing			38	7K7 C	
<b>KAWASAKI Z1000</b>	03	06			
MOTORE / engine			37	3K1 M	
TELAIO / frame			33	3K1 T	
CARENA / fairing			35	3K1 C	
<b>KAWASAKI Z1000</b>	07	08			
MOTORE / engine			42	7K1 M	
TELAIO / frame			46	7K1 T	
CARENA / fairing			44	7K1 C	
<b>KAWASAKI Z1000</b>	09	09			
MOTORE / engine			42	9K1 M	
TELAIO / frame			45	9K1 T	
CARENA / fairing			50	9K1 C	

## Kit viti

## Screw kit

modello - model	anno - years		quantità - pieces	codice - code	€
	dal - from	al - to			
<b>KAWASAKI Z1000</b>	10	11			
MOTORE / engine			25	0KZ M	
TELAIO / frame			41	0KZ T	
<b>KAWASAKI Z1000 SX</b>	11				
MOTORE / engine			21	1KS M	
TELAIO / frame			46	1KS T	
CARENA / fairing			50	1KS C	
<b>KAWASAKI ZX10 R</b>	04	05			
MOTORE / engine			32	4K1 M	
TELAIO / frame			28	4K1 T	
CARENA / fairing			58	4K1 C	
<b>KAWASAKI ZX10 R</b>	06	07			
MOTORE / engine			36	6K1 M	
TELAIO / frame			35	6K1 T	
CARENA / fairing			57	6K1 C	
<b>KAWASAKI ZX10 R</b>	08	10			
MOTORE / engine			26	8K1 M	
TELAIO / frame			32	8K1 T	
CARENA / fairing			54	8K1 C	
<b>KAWASAKI ZX10 R</b>	11				
MOTORE / engine			33	1K1 M	
TELAIO / frame			34	1K1 T	
CARENA / fairing			47	1K1 C	
<b>KAWASAKI ER-6N</b>	06	08			
MOTORE / engine			35	6KR M	
TELAIO / frame			21	6KR T	
CARENA / fairing			39	6KR C	
<b>KAWASAKI ER-6N</b>	09	11			
MOTORE / engine			33	9KR M	
TELAIO / frame			18	9KR T	
CARENA / fairing			40	9KR C	
<b>KTM</b>					
<b>KTM 690</b>	07	10			
MOTORE / engine			28	7M6 M	
TELAIO / frame			23	7M6 T	
CARENA / fairing			26	7M6 C	
<b>KTM SUPER DUKE 990</b>	07	10			
MOTORE / engine			29	7M9 M	
TELAIO / frame			30	7M9 T	
CARENA / fairing			21	7M9 C	
<b>KTM RC8 1190</b>	08	10			
MOTORE / engine			28	8M8 M	
TELAIO / frame			22	8M8 T	
CARENA / fairing			44	8M8 C	
<b>MOTO GUZZI</b>					
<b>MOTO GUZZI GRISO</b>	05	07			
MOTORE / engine			35	5GG M	
TELAIO / frame			26	5GG T	
CARENA / fairing			47	5GG C	

modello - model	anno - years		quantità - pieces	codice - code	€
	dal - from	al - to			
<b>MV</b>					
<b>MV AGUSTA F4 750/1000</b>	00	09			
TELAIO / frame			26	MV4 T	
CARENA / fairing			61	MV4 C	
GANCI RAPIDI / quick fairing fasteners			17	MV4 GR	
<b>MV AGUSTA BRUTALE</b>	04	10			
MOTORE / engine			35	MV5 M	
TELAIO / frame			15	MV5 T	
CARENA / fairing			47	MV5 C	
<b>SUZUKI</b>					
<b>SUZUKI GSR 750</b>	11				
MOTORE / engine			34	1SR M	
TELAIO / frame			27	1SR T	
CARENA / fairing			42	1SR C	
<b>SUZUKI GSXR 600/750</b>	04	05			
MOTORE / engine			32	4S6 M	
TELAIO / frame			36	4S6 T	
CARENA / fairing			52	4S6 C	
<b>SUZUKI GSXR 600/750</b>	06	07			
MOTORE / engine			30	6S6 M	
TELAIO / frame			28	6S6 T	
CARENA / fairing			47	6S6 C	
<b>SUZUKI GSXR 600/750</b>	08	10			
MOTORE / engine			33	8S6 M	
TELAIO / frame			26	8S6 T	
CARENA / fairing			48	8S6 C	
<b>SUZUKI GSXR 600/750</b>	11				
MOTORE / engine			31	1SX M	
TELAIO / frame			38	1SX T	
CARENA / fairing			48	1SX C	
<b>SUZUKI GSXR 1000</b>	03	04			
MOTORE / engine			38	3S1 M	
TELAIO / frame			36	3S1 T	
CARENA / fairing			52	3S1 C	
<b>SUZUKI GSXR 1000</b>	05	06			
MOTORE / engine			38	5S1 M	
TELAIO / frame			38	5S1 T	
CARENA / fairing			46	5S1 C	
<b>SUZUKI GSXR 1000</b>	07	08			
MOTORE / engine			32	7S1 M	
TELAIO / frame			39	7S1 T	
CARENA / fairing			48	7S1 C	
<b>SUZUKI GSXR 1000</b>	09	11			
MOTORE / engine			25	9S1 M	
TELAIO / frame			22	9S1 T	
CARENA / fairing			49	9S1 C	
<b>SUZUKI GSR 600</b>	06	11			
MOTORE / engine			39	6SR M	
TELAIO / frame			26	6SR T	
CARENA / fairing			28	6SR C	
<b>SUZUKI GLADIUS</b>	09	11			
MOTORE / engine			30	9SG M	
TELAIO / frame			20	9SG T	
CARENA / fairing			37	9SG C	

## Kit viti

## Screw kit

modello - model	anno - years		quantità - pieces	codice - code	€
	dal - from	al - to			
<b>TRIUMPH</b>					
<b>TRIUMPH SPEED TRIPLE 955</b>	02	04			
MOTORE / engine			60	2TT M	
TELAIO / frame			25	2TT T	
CARENA / fairing			47	2TT C	
<b>TRIUMPH SPEED TRIPLE 1050</b>	05	07			
MOTORE / engine			57	5TT M	
TELAIO / frame			25	5TT T	
CARENA / fairing			44	5TT C	
<b>TRIUMPH SPEED TRIPLE 1050</b>	08	10			
MOTORE / engine			55	8TT M	
TELAIO / frame			24	8TT T	
CARENA / fairing			37	8TT C	
<b>TRIUMPH SPEED TRIPLE 1050</b>	11				
MOTORE / engine			52	0TT M	
TELAIO / frame			33	0TT T	
CARENA / fairing			48	0TT C	
<b>TRIUMPH DAYTONA 675</b>	07	11			
MOTORE / engine			33	7TD M	
TELAIO / frame			34	7TD T	
CARENA / fairing			46	7TD C	
<b>TRIUMPH STREET TRIPLE 675</b>	07	11			
MOTORE / engine			36	7T6 M	
TELAIO / frame			29	7T6 T	
CARENA / fairing			33	7T6 C	
<b>YAMAHA</b>					
<b>YAMAHA T MAX</b>	04	07			
MOTORE / engine			16	4YT M	
CARENA / fairing			48	4YT C	
<b>YAMAHA T MAX</b>	08	11			
MOTORE / engine			17	8YT M	
CARENA / fairing			43	8YT C	
<b>YAMAHA FAZER 600 + FZ6 600</b>	04	11			
MOTORE / engine			40	4Y6 M	
TELAIO / frame			24	4Y6 T	
CARENA / fairing			38	4Y6 C	
<b>YAMAHA FAZER 1000</b>	01	05			
MOTORE / engine			32	1YF M	
CARENA / fairing			81	1YF C	
<b>YAMAHA FZ1</b>	06	11			
MOTORE / engine			35	6Y1 M	
TELAIO / frame			22	6Y1 T	
CARENA / fairing			58	6Y1 C	
<b>YAMAHA FZ8</b>	10	11			
MOTORE / engine			28	0Y8 M	
TELAIO / frame			28	0Y8 T	
CARENA / fairing			51	0Y8 C	
<b>YAMAHA R6</b>	03	04			
MOTORE / engine			38	3Y8 M	
TELAIO / frame			27	3Y8 T	
CARENA / fairing			70	3Y8 C	
<b>YAMAHA R6</b>	05	05			
MOTORE / engine			38	5Y6 M	
TELAIO / frame			26	5Y6 T	
CARENA / fairing			76	5Y6 C	



modello - model	anno - years		quantità - pieces	codice - code	€
	dal - from	al - to			
<b>YAMAHA R6</b>	06	07			
MOTORE / engine			32	6Y6 M	
TELAIO / frame			28	6Y6 T	
CARENA / fairing			60	6Y6 C	
<b>YAMAHA R6</b>	08	11			
MOTORE / engine			32	8Y6 M	
TELAIO / frame			22	8Y6 T	
CARENA / fairing			54	8Y6 C	
<b>YAMAHA R1</b>	02	03			
MOTORE / engine			29	2Y1 M	
TELAIO / frame			27	2Y1 T	
CARENA / fairing			51	2Y1 C	
GANCI RAPIDI / quick fairing fasteners			14	2Y1 GR	
<b>YAMAHA R1</b>	04	06			
MOTORE / engine			26	4Y1 M	
TELAIO / frame			28	4Y1 T	
CARENA / fairing			62	4Y1 C	
GANCI RAPIDI / quick fairing fasteners			18	4Y1 GR	
<b>YAMAHA R1</b>	07	08			
MOTORE / engine			33	7Y1 M	
TELAIO / frame			33	7Y1 T	
CARENA / fairing			52	7Y1 C	
GANCI RAPIDI / quick fairing fasteners			12	7Y1 GR	
<b>YAMAHA R1</b>	09	11			
MOTORE / engine			33	9Y1 M	
TELAIO / frame			23	9Y1 T	
CARENA / fairing			52	9Y1 C	
GANCI RAPIDI / quick fairing fasteners			14	9Y1 GR	
<b>YAMAHA XJ6</b>	08	11			
MOTORE / engine			28	8YJ M	
TELAIO / frame			18	8YJ T	
CARENA / fairing			48	8YJ C	
<b>YAMAHA MT - 03</b>	06	11			
MOTORE / engine			30	6YM M	
TELAIO / frame			25	6YM T	
CARENA / fairing			44	6YM C	

**Starter kit viti**

Starter screw kit

**NEW**

modello - model	quantità - pieces	codice - code	€
<b>STARTER KIT</b>			
Solo viteria - 2 colori / Only bolts and screw - 2 colours	305	KIT001	
Solo viteria - 3 colori / Only bolts and screw - 3 colours	457	KIT002	

# Kit viti cupolino

## Windscreen screw kit

modello - model	anno - years		quantità - pieces	codice - code	€
	dal - from	al - to			
<b>APRILIA</b>					
APRILIA TUONO 1000	06	09	8	KC001	
APRILIA RSV 1000 R	04	05	8	KC050	
APRILIA RSV4 FACTORY	09	11	4	KC059	
<b>BMW</b>					
BMW S 1000 RR	09	11	8	KC006	
<b>DUCATI</b>					
DUCATI 748 - 916 - 996 - 749 - 999		06	9	KC009	
DUCATI DS 1000 Multistrada	03	09	13	KC011	
DUCATI 1098 + 1198 + 848	07	11	8	KC054	
<b>HONDA</b>					
HONDA CBR 1000	04	07	6	KC013	
HONDA CBR 1000	08	11	4	KC015	
HONDA CBR 600	03	06	6	KC013	
HONDA CBR 600	07	11	8	KC028	
HONDA CBR RR 954	02	03	13	KC019	
HONDA HORNET 600	03	06	8	KC051	
HONDA HORNET 600	07	10	2	KC053	
<b>KAWASAKI</b>					
KAWASAKI 250 R	09	11	4	KC015	
KAWASAKI ZX6 R	03	04	8	KC028	
KAWASAKI ZX6R	05	11	6	KC025	
KAWASAKI ZX10R	04	11	6	KC025	
KAWASAKI Z 1000	03	06	4	KC015	
KAWASAKI Z1000	07	11	4	KC055	
KAWASAKI Z1000 SX	11		8	KC022	
<b>KTM</b>					
KTM SUPER DUKE 990	08	11	4	KC056	
<b>MV</b>					
F4 750 + 1000	00	09	10	KC030	
<b>SUZUKI</b>					
SUZUKI GSXR 600 / 750	04	05	4	KC040	
SUZUKI GSXR 600 / 750	06	11	6	KC042	
SUZUKI GSXR 1000	03	04	12	KC052	
SUZUKI GSXR 1000	05	11	6	KC042	
<b>TRIUMPH</b>					
TRIUMPH DAYTONA 675	07	09	8	KC006	
<b>YAMAHA</b>					
YAMAHA FAZER 600 + FZ6	04	11	6	KC049	
YAMAHA FAZER 1000	01	05	8	KC033	
YAMAHA R1	98	06	6	KC013	
YAMAHA R6	03	11	4	KC015	
YAMAHA FZ8	10	11	2	KC061	

## Kit viti per tappo serbatoio originale

OEM fuel cap screw kit

modello - model	anno - years		codice - code	€
	dal - from	al - to		
<b>APRILIA</b>				
APRILIA RSV 1000	04	05	KTA1000	
APRILIA Tuono	06	09	KTA1000	
APRILIA Shiver 750	07	11	KTA1000	
<b>BENELLI</b>				
BENELLI TNT	04	10	KTA1000	
<b>DUCATI</b>				
DUCATI			KTD	
DUCATI MULTISTRADA 1200 S	10	11	KTD002	
<b>GUZZI</b>				
GUZZI GRISO	05	07	KTGG	
<b>HONDA</b>				
HONDA CBR 600	01	11	KTH01	
HONDA CBR 954	02	03	KTH01	
HONDA CBR 1000	04	11	KTH01	
HONDA CB 1000 R	08	11	KTH01	
HONDA HORNET 600	03	11	KTH01	
HONDA HORNET 900	02	07	KTH01	
<b>KAWASAKI</b>				
KAWASAKI 250R	09	11	KTK6	
KAWASAKI ZX6R	00	06	KTK5	
KAWASAKI ZX6R	07	11	KTK1	
KAWASAKI ER - 6N	06	08	KTK5	
KAWASAKI ER - 6N	09	11	KTK1	
KAWASAKI Z1000	03	11	KTK1	
KAWASAKI Z1000 SX	11		KTK1	
KAWASAKI ZX10R	04	11	KTK1	
KAWASAKI Z750	04	11	KTK1	
<b>MV</b>				
MV AGUSTA	00		KTY5	
<b>SUZUKI</b>				
SUZUKI GSXR 1000	03	11	KTYT	
SUZUKI GSXR 600 / 750	04	11	KTYT	
SUZUKI GSR 600	06	11	KTYT	
SUZUKI SV 650	03	08	KTYT	
SUZUKI tutte escluso cod. KTYT - all excluded code KTYT			KTS	
<b>TRIUMPH</b>				
TRIUMPH			KTYB	
<b>YAMAHA</b>				
YAMAHA R6	03	11	KTYT	
YAMAHA R1	04	11	KTYT	
YAMAHA FZ6 + FAZER 600	04	11	KTYT	
YAMAHA FAZER 1000	01	05	KTY5	
YAMAHA FZ1 + FAZER 1000	06	11	KTYT	
YAMAHA XJ6	08	11	KTYT	
YAMAHA FZ8	10	11	KTYT	

**DADI  
SPECIALI  
SPECIAL  
NUTS**

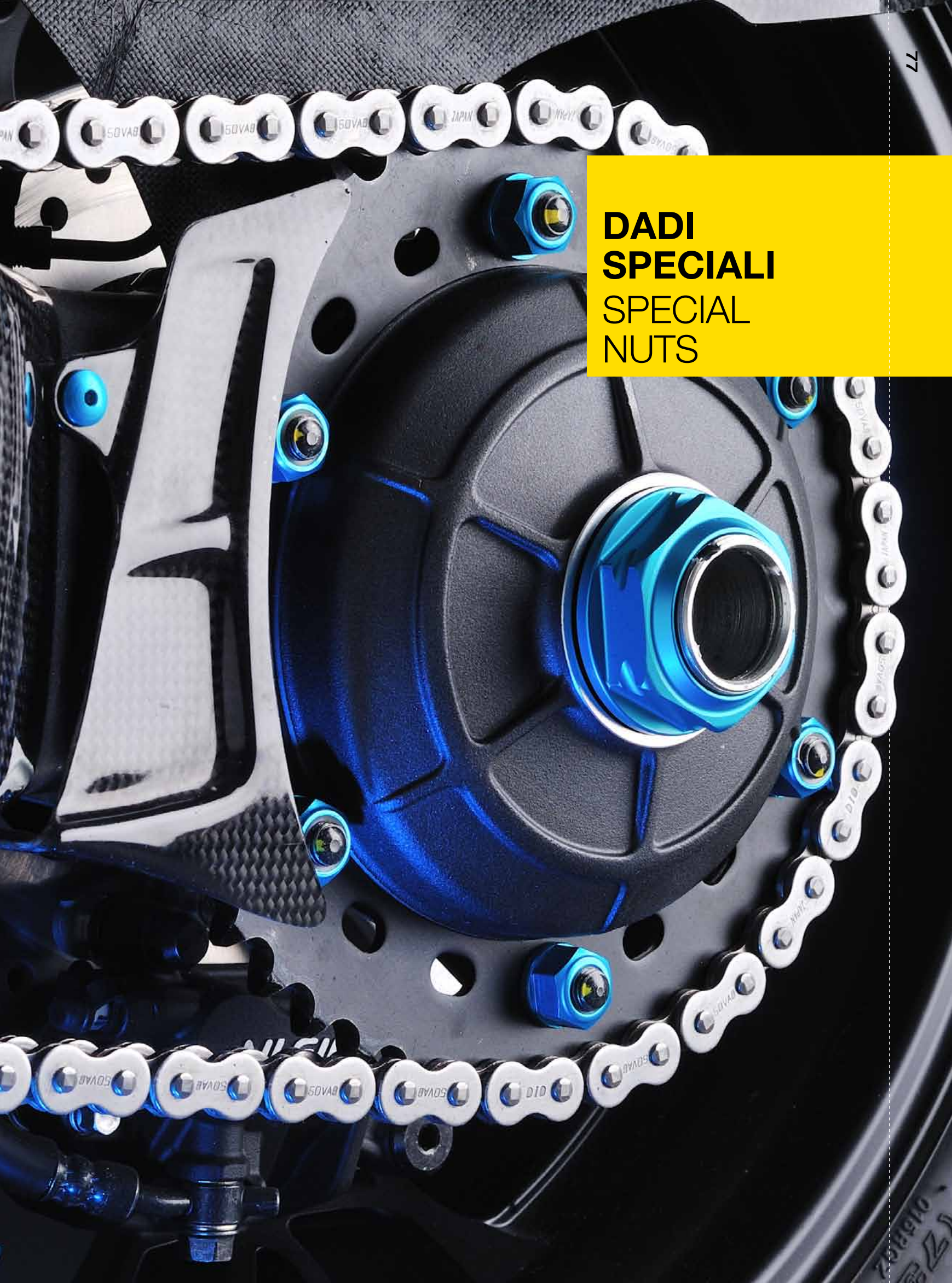

## Dadi speciali ergal 7075

7075 ergal special nuts



Colori disponibili:  
Available colours:

silver  
silver

blu  
blue

indaco  
indigo

nero  
black

oro  
gold

rosso  
red



M 25 X 1,5

D001	posizione - position	modello - model	anno - years	
			dal - from	al - to
Perno forcellone - Swing arm pivot shaft		SUZUKI GSXR 600 / 750	04	05
		SUZUKI GSXR 1000	03	04
Perno ruota posteriore - Rear wheel axle		APRILIA RSV 1000	04	05
		APRILIA RSV4 FACTORY	09	11
		APRILIA TUONO V4	11	
		APRILIA DORSODURO 750	08	11
		APRILIA SHIVER 750	07	11
		APRILIA TUONO	06	09
		SUZUKI GSXR 600 / 750	04	11
		SUZUKI GSXR 1000	03	11
		SUZUKI SV 1000	03	06
		Perno ruota anteriore - Front wheel axle		APRILIA RSV 1000
APRILIA RSV4 FACTORY	09			11
APRILIA TUONO V4	11			
APRILIA DORSODURO 750	08			11
APRILIA SHIVER 750	07			11
GUZZI GRISO	05			09



M 25 X 1

D002	posizione - position	modello - model	anno - years	
			dal - from	al - to
Canotto sterzo / Steering stem head		KAWASAKI ZX6R	03	04
		KAWASAKI Z750	04	06



M 24 X 1,5

D003	posizione - position	modello - model	anno - years	
			dal - from	al - to
Perno ruota posteriore / Rear wheel axle		BMW S 1000 RR	09	11
		KAWASAKI Z 1000	03	09
		KAWASAKI ZX6R	03	11
		YAMAHA Fazer 600 + FZ6 + FZ8	04	11
		YAMAHA FZ8	10	11
		YAMAHA Fazer 1000 + FZ1	01	11
		YAMAHA R6	03	11
		YAMAHA R1	04	11
Perno ruota anteriore / Front wheel axle		KAWASAKI ZX10	06	07



M 18 X 1,5

D004	posizione - position	modello - model	anno - years	
			dal - from	al - to
Perno ruota posteriore / Rear wheel axle		HONDA Hornet 900	02	08
		HONDA Hornet 600	07	11
		KAWASAKI Z750	04	11
		KAWASAKI ZX10	04	10
		KAWASAKI ER-6N	06	09
		SUZUKI SV 650	03	08
		SUZUKI GSXR 600/750	11	
		TRIUMPH STREET TRIPLE 675	07	10
		TRIUMPH DAYTONA 675	07	11
		Perno forcellone / Swing arm pivot shaft		BMW S 1000 RR
HONDA CBR 600	07			11
HONDA CBR 954	02			03
HONDA CB 1000 R	08			11
HONDA Hornet 600	07			11
SUZUKI SV 650	03			08
YAMAHA Fazer 600 + FZ6	04			11
YAMAHA FZ8	10			11
YAMAHA R1	04			06
YAMAHA R6	03			05
YAMAHA FZ1	06			11



M 22 x 1

D005	posizione - position	modello - model	anno - years	
			dal - from	al - to
Canotto sterzo / Steering stem head		YAMAHA Fazer 600 + FZ6	04	11
		YAMAHA MT - 03	06	11
		YAMAHA XJ6	08	11
		SUZUKI Gladius	09	11



M 24 x 1

D006	posizione - position	modello - model	anno - years	
			dal - from	al - to
Canotto sterzo / Steering stem head		HONDA CBR 600	03	11
		HONDA CBR 954	02	03
		HONDA Hornet 600	03	10
		HONDA Hornet 600	11	
		HONDA Hornet 900	02	08
		HONDA CB 1000 R	08	11
		SUZUKI GSXR 600/750	11	
		TRIUMPH DAYTONA 675	07	11



M 14 x 1,5

D007	posizione - position	modello - model	anno - years	
			dal - from	al - to
Perno forcellone / Swing arm pivot shaft		HONDA Hornet 600	03	06
		YAMAHA XJ6	08	11
Perno ruota anteriore / Front wheel axle		KAWASAKI 250R	09	11



38 x 1,5

D008	posizione - position	modello - model	anno - years	
			dal - from	al - to
Perno ruota posteriore / Rear wheel axle		DUCATI 748 - 916 - 996 -998	96	01
		DUCATI DS 1000 Multistrada	03	11
		DUCATI MONSTER S4R	03	04
		DUCATI HYPERMOTARD	07	11
		1100 lato sx / left side		

## Dadi speciali ergal 7075

### 7075 ergal special nuts



33 x 1,5

D009	posizione - position	modello - model	anno - years	
			dal - from	al - to
Perno corona / Rear sprocket		DUCATI 748 - 916 - 996 - 998	96	01
		DUCATI DS 1000 Multistrada	03	09
		DUCATI HYPERMOTARD 1100 lato dx / right side	07	11
Perno ruota posteriore / Rear wheel axle		DUCATI 848 lato sx / left side	07	11



20 x 1,5

D010	posizione - position	modello - model	anno - years	
			dal - from	al - to
Perno forcellone / Swing arm pivot shaft		APRILIA TUONO	03	05
		APRILIA RSV 1000	04	05
		APRILIA RSV4 FACTORY	09	11
		APRILIA DORSODURO 750	08	11
		APRILIA SHIVER 750	07	11
		APRILIA TUONO V4	11	
		KAWASAKI ER - ww6N	09	11
		KAWASAKI ZX6R	03	11
		KAWASAKI ZX10R	04	11
		KAWASAKI Z1000	07	11
		KAWASAKI Z1000 SX	11	
		KAWASAKI Z750	04	11
		SUZUKI GSXR 1000	05	11
		SUZUKI GSXR 600 / 750	06	11
		SUZUKI GSR 600	06	11
		YAMAHA R1	07	11



16 x 1,5

D011	posizione - position	modello - model	anno - years	
			dal - from	al - to
Perno ruota posteriore / Rear wheel axle		HONDA Hornet 600	03	06
		KAWASAKI 250R	09	11
		YAMAHA MT - 03	06	11
		YAMAHA XJ6	08	11
Perno forcellone / Swing arm pivot shaft		YAMAHA MT - 03	06	11
		TRIUMPH STREET TRIPLE 675	07	10
		TRIUMPH DAYTONA 675	07	11



24 x 1,5

D013	posizione - position	modello - model	anno - years	
			dal - from	al - to
Canotto sterzo / Steering stem head		SUZUKI GSXR 600 / 750	04	05
		SUZUKI SV 650	03	08
		SUZUKI GSR 600	06	11
		KAWASAKI ZX10R	11	



28 x 1

D014	posizione - position	modello - model	anno - years	
			dal - from	al - to
Canotto sterzo / Steering stem head		BMW S 1000 RR	09	11
		KAWASAKI ZX6R	05	11
		KAWASAKI ZX10R	04	07
		KAWASAKI ZX10R	11	
		SUZUKI GSXR 1000	03	11
		SUZUKI GSXR 600 / 750	06	11
		YAMAHA R1	04	11
		YAMAHA R6	03	11
		YAMAHA FZ1	06	11
		YAMAHA FZ8	10	11



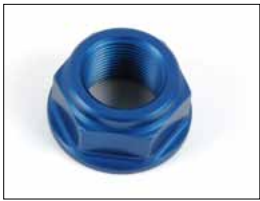

22 x 1,5

D018	posizione - position	modello - model	anno - years	
			dal - from	al - to
Perno ruota posteriore / Rear wheel axle		HONDA CBR 1000	04	11
		HONDA CBR 600	03	11
		HONDA CBR 954	02	03
		SUZUKI GSR 600	06	11
		SUZUKI GSXR 600	11	
Perno forcellone / Swing arm pivot shafte		HONDA CBR 1000	04	11
		YAMAHA R6	06	11
		lato sx / left side		



25 x 1,25

D019	posizione - position	modello - model	anno - years	
			dal - from	al - to
Perno ruota anteriore / Front wheel axle		DUCATI 748-916-996-998	96	01
		DUCATI DS 1000 Multistrada	03	09
		DUCATI Monster		
		DICATI Dark 620 IE	02	07
		DUCATI HYPERMOTARD 1100	07	11



38 x 1,5

D020	posizione - position	modello - model	anno - years	
			dal - from	al - to
Perno ruota posteriore / Rear wheel axle		DUCATI 848 lato dx / right side	07	11
		TRIUMPH Speed Triple 1050 lato dx / right side	05	10



35 x 1,5

D021	posizione - position	modello - model	anno - years	
			dal - from	al - to
Perno corona / Rear wheel axle		TRIUMPH Speed Triple 1050 lato sx / left side	05	10



33 x 1

D022	posizione - position	modello - model	anno - years	
			dal - from	al - to
Canotto sterzo / Steering stem head		HONDA CBR 1000	08	11



35 x 1,5

D023	posizione - position	modello - model	anno - years	
			dal - from	al - to
Perno ruota posteriore / Rear wheel axle		HONDA CB 1000 R	08	11



Michel Fabrizio



The champion



Carlos Checa



Yamaha Tech3 Team



Bradley Smith



**TAPPI  
CAPS**

## Tappi serbatoio attacco rapido

Fuel tank caps with rapid locking



Colori disponibili:  
Available colours:

silver  
silver

blu  
blue

indaco  
indigo

nero  
black

oro  
gold

rosso  
red



Model TR1-2-6-10-11



Model TR3

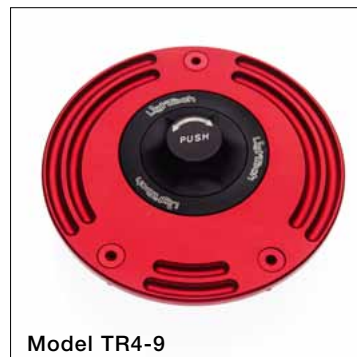

Model TR4-9



Model TR5

modello - model	anno - years		codice - code	€
	dal - from	al - to		
APRILIA			TR5	
APRILIA RSV 1000	04	08	TR10	
APRILIA RSV4 Factory	09	11	TR10	
APRILIA TUONO V4	11		TR10	
BMW S 1000 RR	09	11	TR11	
DUCATI STREETFIGHTER	09	11	TR10	
DUCATI			TR1	
GUZZI			TR5	
HONDA			TR2	
KAWASAKI			TR4	
KAWASAKI ZX10 R	06	11	TR9	
KAWASAKI ZX6R	07	11	TR9	
MV AGUSTA			TR1	
SUZUKI			TR3	
SUZUKI GSXR 1000	03	11	TR6	
SUZUKI GSXR 600 / 750	04	11	TR6	
SUZUKI GSR 600	06	11	TR6	
SUZUKI GSR 750	11		TR6	
TRIUMPH			TR5	
YAMAHA			TR1	
DUCATI 749 - 999	02	06	TR7	
DUCATI DS 1000 Multistrada	03	09	TR7	



Model TR7

### Ricambio Flangia interna - Internal spare part



codice - code

€

TRF

Colori disponibili: nero  
Available colours: black

## Tappi serbatoio attacco a vite

Fuel tank caps with spin locking



Colori disponibili:  
Available colours:

silver  
silver

blu  
blue

indaco  
indigo

nero  
black

oro  
gold

rosso  
red



Model TF1-2-6-10-11



Model TF4-9

modello - model	anno - years		codice - code	€
	dal - from	al - to		
APRILIA RSV4 Factory	09	11	TF10	
APRILIA RSV 1000	04	08	TF10	
APRILIA TUONO V4	11		TF2	
BMW S1000 RR	09	11	TF11	
DUCATI Streetfighter	09	11	TF10	
DUCATI			TF1	
HONDA			TF2	
KAWASAKI			TF4	
KAWASAKI ZX10 R	06	11	TF9	
KAWASAKI Z 1000 SX	11		TF9	
KAWASAKI ZX6R	07	11	TF9	
MV AGUSTA			TF1	
SUZUKI GSXR 1000	03	11	TF6	
SUZUKI GSXR 600 / 750	04	11	TF6	
SUZUKI GSR 600	06	11	TF6	
SUZUKI GSR 750	11		TF6	
YAMAHA			TF1	

### Ricambio Flangia interna - Internal spare part



Colori disponibili: nero  
Available colours: black

codice - code	€
TFC	

### Chiave racing - Racing key



codice - code	€
TFT	

### Valvola sfiato benzina - Breathing valve



Colori disponibili: nero/oro  
Available colours: black/gold

codice - code	€
VALB09	

## Tappi olio

Oil filler caps



Colori disponibili:  
Available colours:

silver  
silver

blu  
blue

indaco  
indigo

nero  
black

oro  
gold

rosso  
red



modello - model	misura - measure	codice - code	€
APRILIA TUONO	M 20 X 1,5	OIL 001	
APRILIA TUONO V4	M 20 X 1,5	OIL 002	
APRILIA SHIVER	M 25 X 1,5	OIL 002	
APRILIA DORSODURO	M 25 X 1,5	OIL 002	
APRILIA RSV 4 + factory	M 25 X 1,5	OIL 002	
BMW S1000 RR	M 24 X 2	OIL 007	
BMW R 1200 GS	M 34 X 1,5	OIL 008	
CAGIVA RAPTOR	M 20 X 1,5	OIL 001	
DUCATI	M 22 X 1,5	OIL 003	
DUCATI 848	M 20 X 2,5	OIL 004	
DUCATI MONSTER 696	M 20 X 2,5	OIL 004	
GUZZI GRISO	M 20 X 1,5	OIL 001	
HONDA	M 20 X 2,5	OIL 004	
KAWASAKI	M 30 X 1,5	OIL 005	
KAWASAKI ER 6N	M 20 X 2,5	OIL 004	
KAWASAKI Z 1000 + SX	M 20 X 2,5	OIL 004	
SUZUKI	M 20 X 1,5	OIL 001	
TRIUMPH	M 20 X 2,5	OIL 004	
YAMAHA	M 26 X 3	OIL 006	
YAMAHA MT 03	M 20 X 2,5	OIL 004	
YAMAHA T-MAX	M 20 X 2,5	OIL 004	

## Chiave racing - Racing key



codice - code	€
TFT	

## Tappi olio

Oil filler caps



modello - model	misura - measure	codice - code	€
APRILIA TUONO	M 20 X 1,5	OILS	
APRILIA TUONO V4	M 20 X 1,5	OILA	
APRILIA SHIVER	M 25 X 1,5	OILA	
APRILIA DORSODURO	M 25 X 1,5	OILA	
APRILIA RSV 4 + factory	M 25 X 1,5	OILA	
BENELLI	M 24 X 1,5	OILB	
BMW S1000 RR	M 24 X 2	OILBM01	
CAGIVA RAPTOR	M 20 X 1,5	OILS	
DUCATI	M 22 X 1,5	OILD	
DUCATI 848	M 20 X 2,5	OILH	
DUCATI MONSTER 696	M 20 X 2,5	OILH	
GUZZI GRISO	M 20 X 1,5	OILS	
HONDA	M 20 X 2,5	OILH	
KAWASAKI	M 30 X 1,5	OILK2	
KAWASAKI ER 6N	M 20 X 2,5	OILH	
KAWASAKI Z 1000	M 20 X 2,5	OILH	
MINARELLI	M 14 X 1,5	OILM	
MORINI CORSARO	M 24 X 1,5	OILB	
MV AGUSTA	M 25 X 1,5	OILMV	
SUZUKI	M 20 X 1,5	OILS	
TRIUMPH	M 20 X 2,5	OILH	
YAMAHA	M 26 X 3	OILY	
YAMAHA MT 03	M 20 X 2,5	OILH	
YAMAHA T-MAX	M 20 X 2,5	OILH	



**FINO A ESAURIMENTO - TO EXHAUSTION**



modello - model	misura - measure	codice - code	€
APRILIA TUONO	M 20 X 1,5	OILSW	
BMW S1000 RR	M 24 X 2	OILBM01W	
DUCATI	M 22 X 1,5	OILDW	
DUCATI 848	M 20 X 2,5	OILHW	
DUCATI MONSTER 696	M 20 X 2,5	OILHW	
GUZZI GRISO	M 20 X 1,5	OILSW	
HONDA	M 20 X 2,5	OILHW	
KAWASAKI	M 30 X 1,5	OILK2W	
KAWASAKI ER 6N / Z 1000 SX	M 20 X 2,5	OILHW	
SUZUKI	M 20 X 1,5	OILSW	
TRIUMPH	M 20 X 2,5	OILHW	
YAMAHA	M 26 X 3	OILYW	
YAMAHA MT 03	M 20 X 2,5	OILHW	
YAMAHA T-MAX	M 20 X 2,5	OILHW	

## Coperchi pompe freno e frizione

Clutch/brake pump reservoir covers



Colori disponibili:  
Available colours:

silver  
silver

blu  
blue

indaco  
indigo

nero  
black

oro  
gold

rosso  
red



modello - model	anno - years		codice - code	€
	dal - from	al - to		
<b>APRILIA</b>				
APRILIA SHIVER 750	07	11	freno post / rear brake	FFC05
APRILIA DORSODURO	09	11	freno ant / front brake	FBC17
			freno post / rear brake	FFC05
			frizione / clutch	FFC06
APRILIA RSV 4 + Factory	09	11	freno ant / front brake	FBC04
APRILIA TUONO V4	11		freno ant / front brake	FBC04
<b>BMW</b>				
BMW S 1000 RR	09	11	freno ant / front brake	FBC06
BMW R 1200 GS	08	11	freno ant / front brake	FBC20
			frizione / clutch	FFC08
<b>DUCATI</b>				
DUCATI STREETFIGHTER	09	11	freno ant / front brake	FBC18
			freno post / rear brake	FFC03
			frizione / clutch	FFC07
DUCATI 696-796	08	11	freno ant / front brake	FBC07
			freno post / rear brake	FFC03
			frizione / clutch	FFC04
DUCATI HYPERMOTARD	07	10	freno ant / front brake	FBC04
			freno post / rear brake	FFC03
			frizione / clutch	FFC03
DUCATI 848	08	11	freno ant / front brake	FBC04
			freno post / rear brake	FFC03
			frizione / clutch	FFC03
DUCATI 749-999	02	06	freno ant / front brake	FBC08
			frizione / clutch	FFC02
DUCATI 1098/1198	07	11	freno ant / front brake	FBC04
			freno post / rear brake	FFC03
			frizione / clutch	FFC03
<b>KAWASAKI</b>				
KAWASAKI 250R	09	11	freno post / rear brake	FBC06
KAWASAKI ZX6R	07	08	freno ant / front brake	FBC06
			freno post / rear brake	FFC05
KAWASAKI ZX6R	09	11	freno ant / front brake	FBC06
KAWASAKI Z750 / Z1000	03	06	freno ant / front brake	FBC02
KAWASAKI Z750	07	11	freno ant / front brake	FBC06
KAWASAKI Z750 R	11		freno ant / front brake	FBC19
KAWASAKI Z1000	07	09	freno ant / front brake	FBC06
KAWASAKI Z1000	10	11	freno ant / front brake	FBC19
KAWASAKI Z1000 / SX	11		freno ant / front brake	FBC06
			freno post / rear brake	FFC05



## Coperchi pompe freno e frizione

### Clutch/brake pump reservoir covers

modello - model	anno - years		codice - code		€
	dal - from	al - to			
KAWASAKI ZX10R	08	11	freno ant / front brake	FBC06	
			freno post / rear brake	FFC05	
KAWASAKI ER - 6N	06	08	freno ant / front brake	FBC02	
KAWASAKI ER-6N	09	11	freno ant / front brake	FBC16	
<b>KTM</b>					
KTM RC8 1190	08	11	freno ant / front brake	FBC06	
KTM 990 SUPER DUKE	07	11	freno ant / front brake	FBC04	
			freno post / rear brake	FFC03	
KTM 690 SM / SMR	07	11	freno ant / front brake	FFC04	
			freno post / rear brake	FFC03	
<b>HONDA</b>					
HONDA CBR 1000	04	05	freno ant / front brake	FBC14	
HONDA CBR 1000	06	11	freno ant / front brake	FBC06	
HONDA CBR 600	03	06	freno ant / front brake	FBC01	
HONDA CBR 600	07	11	freno ant / front brake	FBC06	
HONDA HORNET 600	03	06	freno ant / front brake	FBC01	
HONDA HORNET 600	11		freno ant / front brake	FBC01	
HONDA CB 1000 R	08	11	freno ant / front brake	FBC06	
			freno post / rear brake	FBC06	
HONDA HORNET 900	02	07	frizione / clutch	FFC05	
			freno ant / front brake	FBC01	
<b>MV</b>					
MV AGUSTA F4	00	09	freno ant / front brake	FBC03	
			frizione / clutch	FFC01	
MV AGUSTA BRUTALE	05	11	freno ant / front brake	FBC03	
			frizione / clutch	FFC01	
<b>SUZUKI</b>					
SUZUKI GSXR 600 / 750	04	10	freno ant / front brake	FBC06	
SUZUKI GSXR 1000	05	06	freno ant / front brake	FBC06	
SUZUKI GSXR 1000	07	08	freno ant / front brake	FBC06	
			frizione / clutch	FFC05	
SUZUKI GSXR 1000	09	11	freno ant / front brake	FBC06	
SUZUKI GSR 600	06	11	freno ant / front brake	FBC13	
SUZUKI GSR 750	11		freno ant / front brake	FBC13	
SUZUKI GLADIUS 650	09	11	freno ant / front brake	FBC13	
<b>YAMAHA</b>					
YAMAHA FAZER 1000	01	05	freno ant / front brake	FBC02	
YAMAHA FZ1	06	11	freno ant / front brake	FBC11	
YAMAHA FZ6	04	06	freno ant / front brake	FBC11	
YAMAHA MT 03	06	11	freno ant / front brake	FBC11	
			freno post / rear brake	FFC05	
YAMAHA T - MAX	04	11	freno ant / front brake	FBC15	
			freno post / rear brake	FBC15	
YAMAHA R6	03	05	freno ant / front brake	FBC06	
YAMAHA R6	06	11	freno ant / front brake	FBC06	
			freno post / rear brake	FFC05	
YAMAHA R1	04	11	freno ant / front brake	FBC06	
YAMAHA XJ6	08	11	freno ant / front brake	FBC11	



Althea Ducati box



Jorge Lorenzo



Xavier Simeon



Colin Edwards

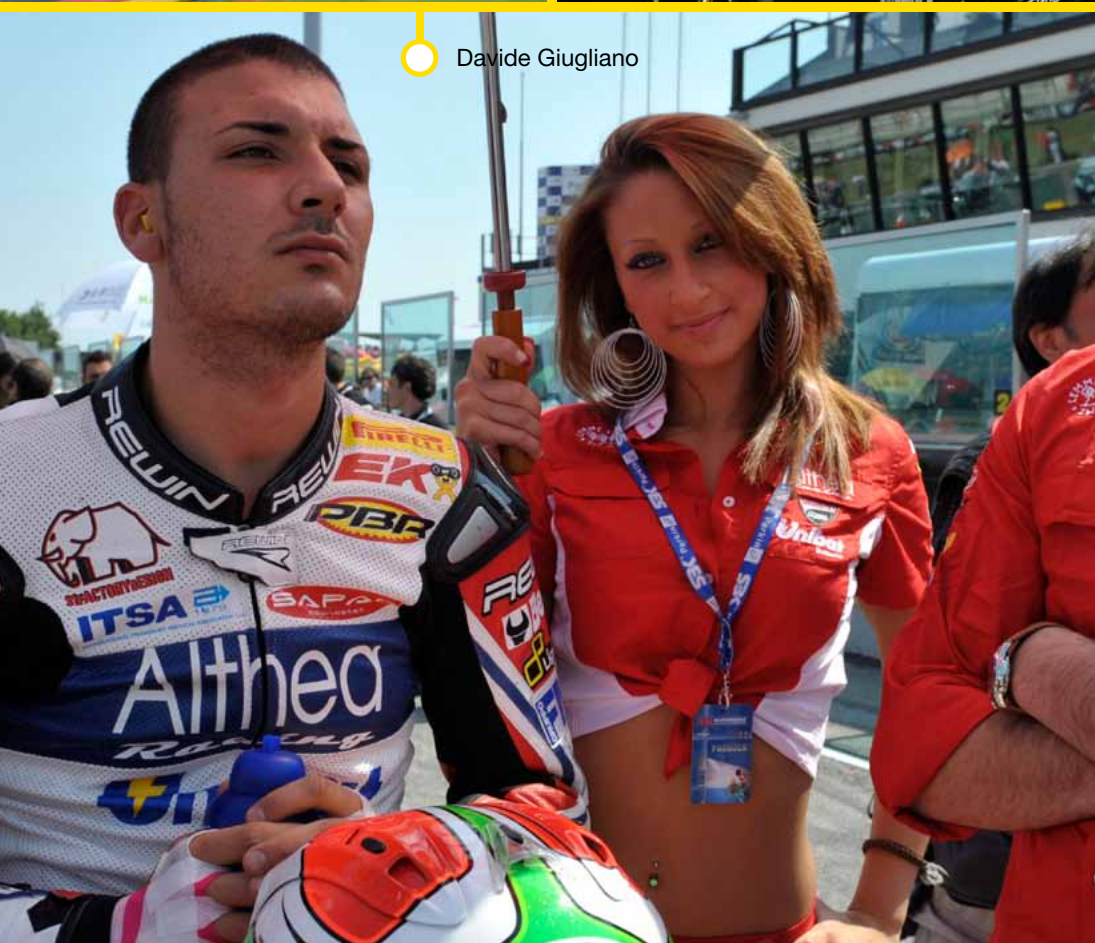

Davide Giugliano



Luca Conforti



**BMW  
R 1200 GS**

**BMW R 1200 GS**

BMW R 1200 GS

**NEW****Protezione motore - Engine protector**

codice - code	anno - years		€
	dal - from	al - to	
STEBM104	08	11	

**Kit tappi telaio - Kit frame cups**

Colori disponibili: silver, nero, indaco.  
Available colours: silver, black, indigo.

codice - code	€
CFT017	

**Coperchi pompe freno e frizione - Clutch/brake pump reservoir covers**

Colori disponibili: silver, nero, indaco.  
Available colours: silver, black, indigo.

codice - code		€
FBC20	freno ant / front brake	
FFC08	frizione / clutch	

**Tappi olio - Oil filler caps**

Colori disponibili: silver, nero, indaco.  
Available colours: silver, black, indigo.

codice - code	€
OIL 008	

**NEW**

**Kit viti teste motore - Screws kit for engine head**



Colori disponibili: silver, nero, indaco.  
Available colours: silver, black, indigo.

codice - code	€
1BGH	

**Protezione telaio - Frame sliders**



codice - code	anno - years		€
	dal - from	al - to	
STEBM103	08	11	

**Contrappesi manubrio - Handlebar balancers**



Colori disponibili: silver, nero, indaco.  
Available colours: silver, black, indigo.

codice - code	€
KTM015	

**Portatarga - License plate brackets**



TARBM103



KTARBM103

codice - code	€
TARBM103	
KTARBM103	

**BMW R 1200 GS**

BMW R 1200 GS

**NEW****Riser - Riser**

Colori disponibili: silver, nero, indaco.  
Available colours: silver, black, indigo.

codice - code	€
RIABM001	

**Kit copricerchio - Wheel cover kit**

codice - code	anno - years		€
	dal - from	al - to	
PMPBM103	08	11	

**Pedane - Rear sets**

codice - code	anno - years		€
	dal - from	al - to	
FTRBM003	08	11	

# T-MAX



**T-Max**

T-Max

**Adattatori specchio - Mirror adaptors**

Colori disponibili: nero - Available colours: black

codice - code	anno - years		€ a coppia - for pair
	dal - from	al - to	
SPEY06	08	11	

**Tappi specchio - Mirror block-off plates**Colori disponibili: rosso, nero, oro, silver.  
Available colours: red, black, gold, silver.

codice - code	anno - years		€ a coppia - for pair
	dal - from	al - to	
SPEY07	08	11	

**Distanziale perno ruota - Wheel axle spacer**Colori disponibili: rosso, nero, oro, silver.  
Available colours: red, black, gold, silver.

codice - code	anno - years		€ a pezzo - for piece
	dal - from	al - to	
DPRYA001	08	11	

**Copricarter - Crankcase cover**Colori disponibili: rosso, nero, oro, silver.  
Available colours: red, black, gold, silver.

codice - code	anno - years		€ a coppia - for pair
	dal - from	al - to	
STEYA002	08	11	



**Protezione perno ruota - Wheel axle slider**



Colori disponibili: rosso, nero, oro, silver.  
Available colours: red, black, gold, silver.

codice - code	anno - years		€
	dal - from	al - to	
STEYA003	08	11	a pezzo - for piece

**Contrappesi manubrio - Handlebar balancers**



**NEW**

*Black & White Series*

Colori disponibili: rosso, nero, oro, silver.  
Available colours: red, black, gold, silver.



codice - code	anno - years		€
	dal - from	al - to	
KTM310	08	11	a coppia - for pair

codice - code	anno - years		€
	dal - from	al - to	
KTM010	08	11	a coppia - for pair

**Coperchi pompa freno - Brake pump cover**



Colori disponibili: rosso, nero, oro, silver.  
Available colours: red, black, gold, silver.

codice - code	anno - years		€
	dal - from	al - to	
FBC15	08	11	a pezzo - for piece

## Portatarga - License plate brackets



codice - code	anno - years		€
	dal - from	al - to	
TARYA112	08	11	
KTARYA112	08	11	

## Specchio - Mirror



codice - code	anno - years		€
	dal - from	al - to	
SPEAL015NER	08	11	a coppia - for pair



codice - code	anno - years		€
	dal - from	al - to	
SPEAL015ROS	08	11	a coppia - for pair

## Leve - Levers



Colori disponibili: nero - Available colours: black

codice - code	anno - years		€
	dal - from	al - to	
KLEV035	08	11	a coppia - for pair

## Leve stazionamento - Parking braker levers



Colori disponibili: rosso, nero, oro, silver.  
Available colours: red, black, gold, silver.

codice - code	anno - years		€
	dal - from	al - to	
LEVD014	08	11	a coppia - for pair

**Accessori carbonio - Carbon parts****Parafango anteriore - Front mudguard**

codice - code	anno - years		€
	dal - from	al - to	
CARY4510	08	11	

**Protezione forcellone - Swingarm protector**

codice - code	anno - years		€
	dal - from	al - to	
CARY 4560	08	11	

**Parafango posteriore - Rear mudguard**

codice - code	anno - years		€
	dal - from	al - to	
CARY4520	08	11	

**Protezione forcellone - Swingarm protector**

codice - code	anno - years		€
	dal - from	al - to	
CARY 4561	08	11	



**SPECCHIETTI**  
MIRRORS

## Specchietti in carbonio

Carbon mirrors



articolo - article	anno - years		codice - code	€
	dal - from	al - to		a coppia - for pair
Base piccola (interasse da 27,5mm a 39mm) Small adaptor (distance between holes 27,5 mm to 39 mm)			SPEC4	
Base grande (interasse da 54,5mm a 69,5mm) Big adaptor (distance between holes 54,5 mm to 69,5 mm)			SPEC2	
Base Ducati 748 - 916 - 996 - 998 Adaptor Ducati 748 - 916 - 996 - 998			SPEC3	
Honda CBR 1000 RR	08	11	SPEHO001	
Kawasaki ZX6R	09	11	SPEKA001	
Kawasaki ZX 10R	11		SPEKA002	
Aprilia RSV4	09	11	SPEAP001	

### Adattatore specchi R6 dal 2008 - Mirrors adaptor R6 from 2008

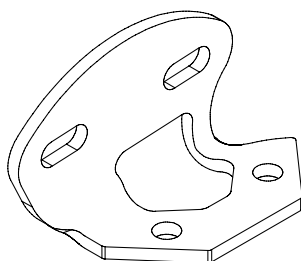

codice - code	a coppia - for pair
SPEY05NER	

## Specchietti in alluminio per naked

Aluminium mirrors for naked



articolo - article	colore - color	codice - code	€
			a coppia - for pair
Specchi alluminio standard (filetto M 10 x 1,25 dx ) Standard aluminium mirrors (filetto M 10 x 1,25 dx )	nero-black	SPEAL014NER	
	argento-silver	SPEAL014SIL	
Specchi alluminio DUCATI Streetfighter (M 8 x 1,25 dx + sx ) Aluminium mirrors DUCATI Streetfighter (M 8 x 1,25 dx + sx )	nero-black	SPEAL014DNER	
	argento-silver	SPEAL014DSIL	
Specchi alluminio YAMAHA (M 10 x 1,25 dx + sx ) Aluminium mirrors YAMAHA (M 10 x 1,25 dx + sx )	nero-black	SPEAL014WNER	
	argento-silver	SPEAL014WSIL	



articolo - article	colore - color	codice - code	€
			a coppia - for pair
Specchi alluminio standard (filetto M 10 x 1,25 dx ) Standard aluminium mirrors (filetto M 10 x 1,25 dx )	nero-black	SPEAL012NER	
	argento-silver	SPEAL012SIL	
Specchi alluminio DUCATI Streetfighter (M 8 x 1,25 dx + sx ) Aluminium mirrors DUCATI Streetfighter (M 8 x 1,25 dx + sx )	nero-black	SPEAL012DNER	
	argento-silver	SPEAL012DSIL	
Specchi alluminio YAMAHA (M 10 x 1,25 dx + sx ) Aluminium mirrors YAMAHA (M 10 x 1,25 dx + sx )	nero-black	SPEAL012WNER	
	argento-silver	SPEAL012WSIL	

## Adattatori specchio

Mirrors adaptor

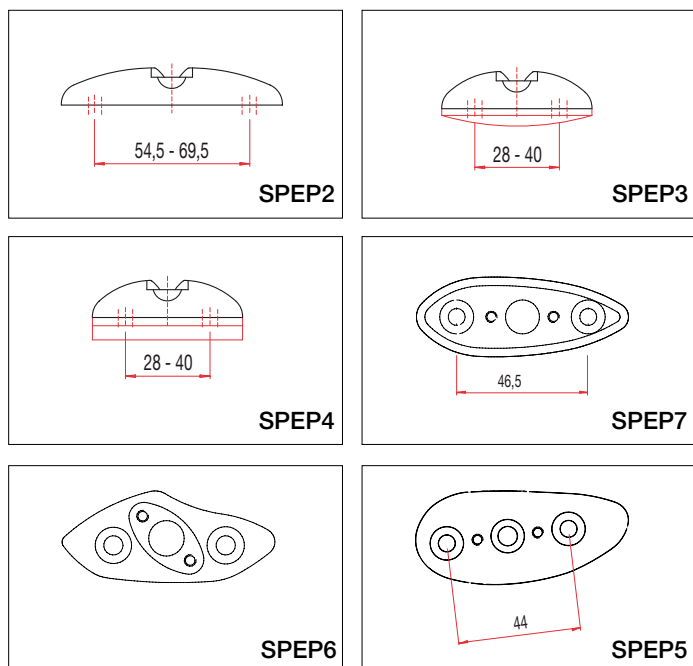

articolo - article	anno - years		codice code	€ a coppia - for pair
	dal - from	al - to		
Base piccola - Small adaptor			SPEP4	
Base grande - Big adaptor			SPEP2	
Base Ducati - Adaptor Ducati			SPEP3	
Aprilia RSV 4			SPEP6	
Honda CBR 1000			SPEP5	
Kawasaki ZX6 R			SPEP7	

## Tappi specchio

Mirror block-off plates



Colori disponibili: indaco, rosso, oro, nero, blu, silver. Available colours: indigo, red, gold, black, blue, silver.

articolo - article	anno - years		codice - code	€ a coppia - for pair
	dal - from	al - to		
APRILIA RSV4 + Factory	09	11	SPE111	
BMW S1000 RR	09	11	SPE109	
HONDA CBR 600 RR	04	11	SPE105	
HONDA CBR 1000 RR	04	07	SPE105	
HONDA CBR 1000 RR	08	11	SPE106	
KAWASAKI ZX6R	03	04	SPE101	
KAWASAKI ZX6R	05	08	SPE102	
KAWASAKI ZX6R	09	11	SPE110	
KAWASAKI ZX10R	04	07	SPE102	
KAWASAKI ZX10R <b>FINO A ESAURIMENTO - TO EXHAUSTION</b>	08	10	SPE108	
KAWASAKI ZX10R	11		SPE112	
SUZUKI GSXR 600 / 750 / 1000	05	11	SPE103	
YAMAHA R6	99	07	SPE104	
YAMAHA R1	98	06	SPE104	
YAMAHA R1	07	08	SPE101	
YAMAHA R1	09	11	SPE107	





**COMPONENTI  
IN CARBONIO**  
CARBON  
PARTS

## Componenti in carbonio

Carbon parts



modello - model	codice - code	€
<b>APRILIA</b>		
<b>APRILIA RSV4 FACTORY   09 - 11</b>		
parafango ant. / front mudguard	CARA3010	
parafango post. / rear mudguard	CARA3020	
coperchio frizione / clutch cover	CARA3030	
coperchio alternatore / electric cover	CARA3040	
protezioni telaio / frame protector	CARA3050	
protezioni forcellone / swingarm protector	CARA3060	
coperchio serbatoio / tank cover	CARA3029	
tubi air box	CARA3019	
copri catena / chain cover	CARA3012	
para catena inferiore / inferior chain protection	CARA3013	
<b>APRILIA TUONO V4   11</b>		
parafango ant. / front mudguard	CARA3010	
parafango post. / rear mudguard	CARA3020	
coperchio frizione / clutch cover	CARA3030	
coperchio alternatore / electric cover	CARA3040	
protezioni forcellone / swingarm protector	CARA3060	
coperchio serbatoio / tank cover	CARA3029	
copri catena / chain cover	CARA3012	
para catena inferiore / inferior chain protection	CARA3013	
<b>BMW</b>		
<b>BMWS 1000 RR   09 - 11</b>		
parafango ant. / front mudguard	CARB1010	
parafango post. / rear mudguard	CARB1020	
coperchio frizione / clutch cover	CARB1030	
coperchio alternatore / electric cover	CARB1040	
coperchio pick up / pick up cover	CARB1018	
protezioni telaio / frame protector	CARB1050	
protezioni forcellone / swingarm protector	CARB1060	
coperchio serbatoio / tank cover	CARB1029	
tubi airbox / racing airducts	CARB1019	



modello - model	codice - code	€
<b>HONDA</b>		
<b>HONDA CBR 600   03 - 04</b>		
parafango ant. / front mudguard	CARH7110	
parafango post. / rear mudguard	CARH7120	
coperchio frizione / clutch cover	CARH7130	
coperchio alternatore / electric cover	CARH7140	
protezioni telaio / frame protector	CARH7150	
protezioni forcellone / swingarm protector	CARH7160	
tubi airbox / racing airducts	CARH7119	
protezione scarico / exhaust protector	CARH7180	
<b>HONDA CBR 600   05 - 06</b>		
parafango ant. / front mudguard	CARH8910	
parafango post. / rear mudguard	CARH8920	
coperchio frizione / clutch cover	CARH8930	
coperchio alternatore / electric cover	CARH8940	
protezioni telaio / frame protector	CARH8950	
protezioni forcellone / swingarm protector	CARH8960	
tubi airbox / racing airducts	CARH8919	
protezione scarico / exhaust protector	CARH8980	
<b>HONDA CBR 600   07 - 11</b>		
parafango ant. / front mudguard	CARH6510	
parafango post. / rear mudguard	CARH8920	
coperchio frizione / clutch cover	CARH6530	
coperchio alternatore / electric cover	CARH6540	
protezioni telaio / frame protector	CARH6550	
protezioni forcellone / swingarm protector	CARH6560	
tubi airbox / racing airducts	CARH6519	
protezione scarico / exhaust protector	CARH6580	
<b>HONDA CBR 1000   04 - 07</b>		
parafango ant. / front mudguard	CARH7410	
parafango post. / rear mudguard	CARH7420	
coperchio frizione / clutch cover	CARH7430	
coperchio alternatore / electric cover	CARH7440	
protezioni telaio / frame protector	CARH7450	
protezioni forcellone / swingarm protector	CARH7414	
protezione scarico / exhaust protector	CARH7480	
protezione catena / chain protector	CARH7412	
supporto strumenti / tachometer support	CARH7470	

## Componenti in carbonio

Carbon parts



modello - model	codice - code	€
<b>HONDA CBR 1000   08 - 11</b>		
parafango ant. / front mudguard	CARH7610	
parafango post. / rear mudguard	CARH7620	
coperchio alternatore / electric cover	CARH7640	
coperchio frizione / clutch cover	CARH7630	
protezioni telaio / frame protector	CARH7650	
protezioni forcellone / swingarm protector	CARH7660	
tubi air box / racing airducts	CARH7619	
coperchio pick up / pick up cover	CARH7618	
supporto strumenti / tachometer support	CARH7670	
<b>HONDA CB 1000   08 - 11</b>		
parafango ant. / front mudguard	CARH7010	
parafango post. / rear mudguard	CARH7020	
coperchio frizione / clutch cover	CARH7030	
coperchio alternatore / electric cover	CARH7040	
copri catena / chain protector	CARH7012	
protezione corona / sprocket cover	CARH7013	
protezioni forcellone / swingarm protector	CARH7060	
frontalino copri strumenti / tachometer support cover	CARH7070	
<b>KAWASAKI</b>		
<b>KAWASAKI ZX6   07 - 08</b>		
parafango ant. / front mudguard	CARK6310	
coperchio frizione / clutch cover	CARK6330	
coperchio alternatore / electric cover	CARK6340	
coperchio pick up / pick up cover	CARK6318	
protezioni telaio / frame protectors	CARK6350	
protezioni forcellone / swingarm protector	CARK6314	
<b>KAWASAKI ZX6   09 - 11</b>		
parafango ant. / front mudguard	CARK9510	
parafango post. / rear mudguard	CARK9520	
coperchio frizione / clutch cover	CARK9530	
coperchio alternatore / electric cover	CARK9540	
coperchio pick up / pick up cover	CARK9518	
protezioni telaio / frame protectors	CARK9550	
protezioni forcellone / swingarm protector	CARK9560	
copri catena / chain protector	CARK9512	



modello - model	codice - code	€
<b>KAWASAKI ZX10   06 - 07</b>		
parafango ant. / front mudguard	CARK6110	
parafango post. + copri catena / rear mudguard + chain protector	CARK6120	
coperchio frizione / clutch cover	CARK6130	
coperchio alternatore / electric cover	CARK6140	
coperchio pick up / pick up cover	CARK6118	
protezioni telaio / frame protector	CARK6150	
protezioni forcellone / swingarm protector	CARK6114	
<b>KAWASAKI ZX10   08 - 09</b>		
parafango ant. / front mudguard	CARK9210	
parafango post. / rear mudguard	CARK9220	
coperchio alternatore / electric cover	CARK6140	
coperchio frizione / clutch cover	CARK9230	
coperchio pick up / pick up cover	CARK6118	
protezioni telaio / frame protector	CARK9250	
protezioni forcellone / swingarm protector	CARK9260	
<b>KAWASAKI ZX10 11</b>		
parafango ant. / front mudguard	CARK9610	
parafango post. / rear mudguard	CARK9620	
coperchio frizione / clutch cover	CARK9630	
coperchio alternatore / electric cover	CARK9640	
coperchio pick up / pick up cover	CARK9618	
protezioni telaio / frame protector	CARK9650	
protezioni forcellone / swingarm protector	CARK9660	
<b>KAWASAKI Z750 07-09</b>		
parafango ant. / front mudguard	CARK6810	
parafango post. / rear mudguard	CARK6820	
coperchio frizione / clutch cover	CARK6830	
coperchio alternatore / electric cover	CARK6840	
coperchio pick up / pick up cover	CARK6818	

## Componenti in carbonio

Carbon parts



modello - model	codice - code	€
<b>MV AGUSTA</b>		
F4 750 00-03 + F4 1000 04-05		
parafango ant. / front mudguard	CARM9810	
parafango post. / rear mudguard	CARM9820	
tubi air box racing / racing airducts	CARM9890	
protezioni forcellone / swingarm protector	CARM9814	
<b>SUZUKI</b>		
<b>SUZUKI GSXR 600 / 750   04 - 05</b>		
parafango ant. / front mudguard	CARS8410	
parafango post. / rear mudguard	CARS8420	
coperchio frizione / clutch cover	CARS8430	
coperchio alternatore / electric cover	CARS8440	
coperchio pick up / pick up cover	CARS8818	
protezioni telaio / frame protection	CARS8450	
protezioni forcellone / swingarm protector	CARS8460	
tubi air box racing / racing airducts	CARS8419	
<b>SUZUKI GSXR 600 / 750   06 - 07</b>		
parafango ant. / front mudguard	CARS6010	
parafango post. / rear mudguard	CARS6020	
coperchio frizione / clutch cover	CARS6030	
coperchio alternatore / electric cover	CARS6040	
protezioni telaio / frame protection	CARS6050	
protezioni forcellone / swingarm protector	CARS6060	
tubi air box racing / racing airducts	CARS6019	
supporto strumenti / tachometer support	CARS6070	
<b>SUZUKI GSXR 600/750   08 - 10</b>		
parafango ant. / front mudguard	CARS6010	
parafango post. / rear mudguard	CARS6020	
coperchio frizione / clutch cover	CARS8030	
coperchio alternatore / electric cover	CARS6040	
protezioni telaio / frame protection	CARS6050	
protezioni forcellone / swingarm protector	CARS6060	
tubi air box racing / racing airducts	CARS8019	



modello - model	codice - code	€
<b>SUZUKI GSXR 600/750   2011</b>		
parafango ant. / front mudguard	CARS6410	
parafango post. / rear mudguard	CARS6420	
coperchio frizione / clutch cover	CARS8030	
coperchio alternatore / electric cover	CARS6040	
protezioni telaio / frame protection	CARS6150	
protezioni forcellone / swingarm protector	CARS6160	
<b>SUZUKI GSXR 1000   05 - 06</b>		
parafango ant. / front mudguard	CARS8810	
parafango post. / rear mudguard	CARS8820	
coperchio frizione / clutch cover	CARS8830	
coperchio alternatore / electric cover	CARS8840	
coperchio pick up / pick up cover	CARS8818	
coperchio pick up + starter / pick up cover + starter	CARS8817	
protezioni telaio / frame protector	CARS8850	
protezioni forcellone / swingarm protector	CARS8860	
tubi air box racing / racing airducts	CARS8819	
<b>SUZUKI GSXR 1000   07 - 08</b>		
parafango ant. / front mudguard	CARS8810	
parafango post. / rear mudguard	CARS8820	
coperchio frizione / clutch cover	CARS8830	
coperchio alternatore / electric cover	CARS8840	
coperchio motorino avviamento / starter cover	CARS8818	
coperchio pick up + starter / pick up cover + starter	CARS8817	
protezioni telaio / frame protector	CARS6750	
protezioni forcellone / swingarm protector	CARS6760	
tubi air box racing / racing airducts	CARS6719	
<b>SUZUKI GSXR 1000   09 - 11</b>		
parafango ant. / front mudguard	CARS6410	
parafango post. / rear mudguard	CARS6420	
coperchio frizione / clutch cover	CARS6430	
coperchio alternatore / electric cover	CARS6440	
protezioni telaio / frame protector	CARS6450	
protezioni forcellone / swingarm protector	CARS6460	
tubi air box racing / racing airducts	CARS6419	

## Componenti in carbonio

Carbon parts



modello - model	codice - code	€
<b>YAMAHA</b>		
<b>YAMAHA YZF R1   04 - 06</b>		
parafango ant. / front mudguard	CARY7810	
parafango post. / rear mudguard	CARY7820	
coperchio frizione 04-05 / clutch cover 04-05	CARY7830	
coperchio frizione 06 / clutch cover 06	CARY7831	
coperchio alternatore / electric cover	CARY7840	
coperchio pick up / pick up cover	CARY7818	
protezioni telaio / frame protector	CARY7850	
protezioni forcellone / swingarm protector	CARY7860	
coperchio serbatoio / tank cover	CARY7829	
tubi air box racing / racing airducts	CARY7819	
<b>YAMAHA R1   07 - 08</b>		
parafango ant. / front mudguard	CARY7810	
parafango post. / rear mudguard	CARY6620	
parafango posteriore con copri catena / rear mudguard with chain protector	CARY6621	
coperchio frizione / clutch cover	CARY6630	
coperchio alternatore / electric cover	CARY6640	
coperchio pick up / pick up cover	CARY6618	
coperchio motore lato sx / left engine cover	CARY6648	
protezioni telaio / frame protector	CARY6650	
protezioni forcellone / swingarm protector	CARY6660	
tubi air box racing / racing airducts	CARY6619	
coperchio serbatoio / tank cover	CARY6629	
<b>YAMAHA R1   09 - 11</b>		
parafango ant. / front mudguard	CARY9710	
parafango posteriore con copri catena / rear mudguard with chain protector	CARY9720	
coperchio frizione / clutch cover	CARY9730	
coperchio alternatore / electric cover	CARY9740	
protezioni telaio / frame protector	CARY9750	
protezioni forcellone / swingarm protector	CARY9760	
coperchio pick up / pick up cover	CARY9718	
tubi air box racing / racing airducts	CARY9719	





modello - model	codice - code	€
<b>YAMAHA YZF R6   03 - 05</b>		
parafango ant. / front mudguard	CARY9010	
parafango post. / rear mudguard	CARY9020	
coperchio frizione / clutch cover	CARY9030	
coperchio alternatore / electric cover	CARY9040	
coperchio pick up / pick up cover	CARY9018	
protezioni telaio / frame protector	CARY9050	
protezioni forcellone / swingarm protector	CARY9060	
tubi air box racing / racing airducts	CARY9019	
<b>YAMAHA YZF R6   06 - 11</b>		
parafango ant. / front mudguard	CARY9910	
parafango post. / rear mudguard	CARY9920	
coperchio frizione / clutch cover	CARY9930	
coperchio alternatore / electric cover	CARY9940	
coperchio pick up / pick up cover	CARY9918	
protezioni telaio / frame protection	CARY9950	
protezioni forcellone / swingarm protector	CARY9960	
tubi air box racing + supp. strumenti / racing airducts + tachometer support (06-07)	CARY9919	
tubi air box racing + supp. strumenti / racing airducts + tachometer support (08-11)	CARY9819	
<b>YAMAHA FZ1   06 - 11</b>		
parafango ant. / front mudguard	CARY4010	
parafango post. / rear mudguard	CARY4020	
coperchio frizione / clutch cover	CARY4030	
coperchio alternatore / electric cover	CARY4040	
coperchio pick up / pick up cover	CARY4018	
copri catena/ chain cover	CARY4012	
<b>YAMAHA T-MAX   08 - 11</b>		
parafango ant. / front mudguard	CARY4510	
parafango post. / rear mudguard	CARY4520	
protezioni forcellone aperto / swingarm protector open	CARY4560	
protezioni forcellone chiuso / swingarm protector close	CARY4561	
<b>PINNA PROTEZIONE CATENA / CHAIN PROTECTION</b>	<b>CAR001</b>	



Cal Crutchow



Alex De Angelis



Ben Spies



Davide Giugliano



**FILTRI**  
FILTERS

**LIGHTTECH**  
**SPORTS**  
**FILTERS**

MORE PROTECTION, MORE PERFORMANCE



## oil air filter spray

code	€
010F0001	



## cleaner air filter

code	€
010F0002	

modello - model	CC	anno - years		codice - code	€
		dal - from	al - to		
<b>APRILIA</b>					
RXV4.5	450	2006	>	010FAP003	
SXV4.5	450	2006	>	010FAP003	
RXV5.5	550	2006	>	010FAP003	
SXV5.5	550	2006	>	010FAP003	
SL SHIVER	750	2008	>	010FAP005	
SMV DORSODURO	750	2009	>	010FAP005	
SL1000 FALCO	1000	2000	2004	010FAP002	
RST 1000 FUTURA 1000	1000	2001	2004	010FAP002	
TUONO FIGHTER	1000	2003	2004	010FAP001	
RSV 1000 SP 1000	1000	2000	2001	010FAP002	
RSV MILLE 1000	1000	1999	2003	010FAP002	
RSV 1000 R	1000	2004	2007	010FAP003	
RSV 1000 R Factory	1000	2005	2007	010FAP003	
TUONO 1000 R	1000	2004	2007	010FAP001	
TUONO RACING 1000	1000	2004	2006	010FAP001	
TUONO R Factory	1000	2005	2007	010FAP003	
RSV4 R (oem cod. 8104329)	1000	2009	>	010FAP003	
RSV4 Factory APRC SE	1000	2011	>	010FAP004	
RSV4 R/Factory (oem cod.858930)	1000	2009	>	010FAP004	
TUONO V4 aprc	1000	2011	>	010FAP004	
DORSODURO 1200	1200	2011	>	010FAP005	
<b>BMW</b>					
F 800 S	800	2006	>	010FBM005	
F 800 ST	800	2006	>	010FBM005	
F 800 GS	800	2007	>	010FBM005	
F 800 R	800	2009	>	010FBM005	
R850R	850	1995	2006	010FBM001	
R850RT	850	1995	2006	010FBM001	
S 1000 RR	1000	2009	>	010FBM002	
R1100GS ABS	1100	1992	1999	010FBM001	
R1100R/R1100R ABS	1100	1994	2001	010FBM001	

modello - model	CC	anno - years		codice - code	€
		dal - from	al - to		
R1100RT ABS	1100	1996	2001	010FBM001	
R1150GS	1150	1999	2003	010FBM001	
R1150R	1150	2001	2006	010FBM001	
R1150RS	1150	2001	2005	010FBM001	
R1150GS Adventure	1150	2002	2005	010FBM001	
R1150R Rockster	1150	2004	2006	010FBM001	
R1200C	1200	1997	2004	010FBM003	
R 1200C Crusier	1200	1998	2001	010FBM003	
R 1200C Indipendent	1200	2001	2003	010FBM003	
R1200C Avantgarde	1200	2001	2002	010FBM003	
R1200C Classic	1200	2001	2003	010FBM003	
R1200C Montauk	1200	2003	2004	010FBM003	
R1200CL	1200	2003	2006	010FBM003	
R 1200 GS	1200	2004	>	010FBM004	
K 1200 S	1200	2004	>	010FBM006	
K 1200 R	1200	2004	>	010FBM006	
K 1200	1200	2004	>	010FBM006	
R 1200 RT	1200	2005	>	010FBM004	
HP2 Enduro	1200	2006	2007	010FBM004	
R 1200 S	1200	2006	>	010FBM004	
HP2 Megamoto	1200	2007	2008	010FBM004	
R 1200 R	1200	2007	>	010FBM004	
<b>BUELL</b>					
S1 Lightning	1200	1996	2002	010FBU001	
M2 Cyclone	1200	1997	2002	010FBU001	
S3 Thunderbolt	1200	1997	2001	010FBU001	
S2 Thunderbolt	1200	1998	2002	010FBU001	
M2 Cyclon Low	1200	2001	>	010FBU001	
BUELL S3 Thunderbolt	1200	2002	>	010FBU001	
BUELL S3T Thunderbolt	1200	2002	>	010FBU001	
BUELL X1 Lightning	1200	2002	>	010FBU001	
1125 R	1200	2007	>	010FBU002	
<b>DUCATI</b>					
MONSTER 400 Dark	400	2002	2003	010FDU004	
MONSTER 400	400	2003	2007	010FDU005	
MONSTER 1000S I.E.	400	2004	2005	010FDU005	
MONSTER 400 Dark IE	400	2005	2005	010FDU005	
600SS	600	1991	1999	010FDU004	
MONSTER 600	600	1993	2001	010FDU004	
MONSTER 620/Dark	620	2002	2006	010FDU005	
MULTISTRADA 620	620	2005	>	010FDU006	
MONSTER 695	695	2007	2007	010FDU005	
MONSTER 696	696	2008	>	010FDU003	
750 PASO	750	1987	>	010FDU004	
750SS	750	1991	1999	010FDU004	
MONSTER 750	750	1996	2001	010FDU004	
750SS I.E.	750	2001	2002	010FDU004	
MONSTER 750 Dark/i.e	750	2002	>	010FDU005	
HYPERMOTARD 796	796	2009	>	010FDU003	
MONSTER 796	796	2010	>	010FDU003	
800SS	800	2003	2007	010FDU004	
MONSTER	800	2003	2004	010FDU005	
MONSTER 800 i.e	800	2003	2004	010FDU005	
MONSTER S2R 800	800	2005	2007	010FDU005	
MONSTER S2R 800 Dark	800	2005	2006	010FDU005	
MONSTER S2R 803	803	2005	2007	010FDU005	

## Filtri

Filters

modello - model	CC	anno - years		codice - code	€
		dal - from	al - to		
848	848	2008	>	010FDU002	
900SS	900	1991	1999	010FDU004	
900 Superlight	900	1992	1997	010FDU004	
MONSTER 900	900	1993	2000	010FDU004	
MONSTER M900 City	900	1999	>	010FDU004	
MONSTER M900 Cromo	900	1999	2001	010FDU004	
MONSTER M900 S	900	1999	2000	010FDU004	
MONSTER 900 Dark	900	2000	>	010FDU004	
MONSTER 900 i.e.	900	2000	2002	010FDU004	
900SS i.e.	900	2001	>	010FDU004	
MONSTER 900 i.e.	900	2001	>	010FDU004	
ST4 916	916	1999	2003	010FDU004	
MONSTER S4 916	916	2001	2003	010FDU005	
ST2 944	944	1997	2003	010FDU004	
ST2	944	2000	2001	010FDU004	
ST3 992	992	2004	2007	010FDU004	
MONSTER S2R 1000	992	2006	2007	010FDU005	
ST4S 996	996	2001	2005	010FDU004	
MONSTER S4 996	996	2003	2006	010FDU005	
998 all models	998	2006	2007	010FDU005	
MONSTER S4R TESTA STRETTA	998	2007	>	010FDU005	
916/996/998 all models	1000	1994	>	010FDU001	
1000SS	1000	2003	2006	010FDU004	
MONSTER 1000 IE	1000	2003	2005	010FDU005	
MULTISTRADA 1000 DS	1000	2003	2006	010FDU006	
MONSTER S2R 1000	1000	2006	2007	010FDU005	
1098 all model	1098	2007	>	010FDU002	
MULTISTRADA 1100	1100	2007	2009	010FDU006	
HYPERMOTARD 1100	1100	2008	>	010FDU003	
MONSTER/S 1100	1100	2009	>	010FDU003	
MONSTER 1100 EVO	1100	2011	>	010FDU003	
1198	1198	2009	>	010FDU002	
STREETFIGHTER/S	1198	2009	>	010FDU002	
DIAVEL	1198	2011	>	010FDU002	
MULTISTRADA 1200/S	1200	2010	>	010FDU002	
<b>GILERA</b>					
GP 800	800	2007	>	010FGI001	
<b>HONDA</b>					
SH/SHi 125	125	2001	>	010FHO011	
@125	125	>	2006	010FHO011	
DYLAND 125	125	>	2006	010FHO011	
SH/SHi 150	150	2001	>	010FHO011	
@150	150	>	2006	010FHO011	
DYLAND 150	150	>	2006	010FHO011	
SH 300	300	2007	>	010FHO012	
CBF500	500	2004	2006	010FHO002	
CB 600 HORNET	600	1998	2006	010FHO002	
CB 600 HORNET	600	2007	>	010FHO005	
CBR600F4	600	2001	2003	010FHO007	
CBF 600	600	2004	2006	010FHO002	
CBF 600 S	600	2004	2006	010FHO002	
CBR 600 F	600	2011	>	010FHO005	
CBR600 RR	600	2004	2006	010FHO008	
CBR 600 RR	600	2007	>	010FHO009	
CB900F HORNET	900	2003	2007	010FHO003	
CBR 1000RR	1000	2004	2007	010FHO004	

modello - model	CC	anno - years		codice - code	€
		dal - from	al - to		
CBR 1000 RR	1000	2008	>	010FHO010	
CB 1000 R	1000	2008	>	010FHO006	
XL700V TRANSALP	700	2008	>	010FHO015	
VFR 800	800	1998	2001	010FHO014	
VFR 800/V-TEC	800	2002	>	010FHO014	
VTR 1000 SP1	1000	2000	2001	010FHO016	
VTR 1000 SP2	1000	2002	>	010FHO016	
<b>KAWASAKI</b>					
NINJA 250 Z	250	2009	>	010FKA013	
ZX6R Ninja	600	1998	2001	010FKA003	
ZX6R Ninja	636	2002	2002	010FKA003	
ZX6R Ninja	636	2003	2004	010FKA004	
ZX6R Ninja	636	2005	2006	010FKA005	
ZX6RR Ninja	600	2003	2004	010FKA004	
ZX6RR Ninja	600	2005	2006	010FKA005	
ZX6R Ninja	600	2007	2008	010FKA010	
ZX6R Ninja	600	2009	>	010FKA012	
ZX9R Ninja	900	1998	2003	010FKA006	
Z 750	750	2004	>	010FKA002	
Z 750 R	750	2011	>	010FKA002	
Z 1000	1000	2003	2006	010FKA002	
Z 1000	1000	2007	2009	010FKA002	
Z 1000	1000	2010	>	010FKA015	
Z 1000 SX	1000	2011	>	010FKA015	
ZX10R Ninja	1000	2004	2007	010FKA007	
ZX10R Ninja	1000	2008	2010	010FKA009	
ZX10R Ninja	1000	2011	>	010FKA014	
GTR1400	1400	2007	>	010FKA011	
ZZR1400	1400	2007	>	010FKA011	
<b>KTM</b>					
690 DUKE/SM	690	2007	2008	010FKT001	
690 SMC/ENDURO/R	690	2008	2009	010FKT002	
990 LC8 SUPERDUKE R	990	2003	2008	010FKT003	
990 LC8 ADVENTURE S	990	2006	>	010FKT003	
990 LC8 ADVENTURE R	990	2009	>	010FKT003	
990 LC8 SM T	990	2009	>	010FKT003	
RC 8 1190	1190	2008	>	010FKT004	
RC 8 1190 R	1190	2009	>	010FKT004	
<b>KYMCO</b>					
DOWNTOWN 300	300	2009	>	010FKY001	
XCITING 500	500	2005	>	010FKY002	
<b>MOTO GUZZI</b>					
BREVA 750 i.e.	750	2003	>	010FGU004	
BREVA 850 i.e	850	2005	>	010FGU001	
BREVA 1.100 i.e	1100	2005	>	010FGU001	
BREVA 1.200 i.e	1200	2007	>	010FGU001	
GRISO 850	850	2005	2008	010FGU003	
GRISO 1100	1100	2005	>	010FGU003	
GRISO 1200	1200	2007	>	010FGU003	
NEVADA 750 i.e.	750	2004	>	010FGU004	
NORGE 850	850	2006	>	010FGU001	
NORGE 1200	1200	2006	>	010FGU001	
STELVIO	1200	2008	>	010FGU003	
V10 CENTAURO 1000	1000	1998	2000	010FGU002	
<b>MOTO MORINI</b>					
GRANPASSO 1200	1200	2008	>	010FMO001	

## Filtri

Filters

modello - model	CC	anno - years		codice - code	€
		dal - from	al - to		
<b>SUZUKI</b>					
B-KING	1400	2008	>	010FSU012	
BURGMAN 400	400	2006	>	010FSU016	
DL 1000 V-STROM	1000	2003	>	010FSU017	
DL 650 V-STROM	650	2003	>	010FSU017	
DRZ400E/SM	400	2001	>	010FSU001	
GSF 600 Bandit	600	1995	1999	010FSU004	
GSF 650 N/BANDIT	650	2005	2008	010FSU011	
GSF 1200 N/Bandit	1200	2000	2008	010FSU011	
GSF 1250 N/Bandit	1250	2007	>	010FSU011	
GSR 600	600	2006	2008	010FSU009	
GSR 750	750	2011	>	010FSU009	
GSXR 600	600	2001	2003	010FSU005	
GSXR 600	600	2004	2005	010FSU006	
GSXR 600	600	2006	>	010FSU007	
GSXR 750W	750	1992	1995	010FSU004	
GSXR 750	750	2004	2005	010FSU006	
GSXR 750	750	2006	2010	010FSU007	
GSXR 1000	1000	2002	2004	010FSU005	
GSXR 1000	1000	2005	2008	010FSU008	
GSXR 1000	1000	2009	>	010FSU015	
HAYABUSA	1300	1999	2007	010FSU013	
HAYABUSA	1300	2008	>	010FSU014	
SFV 650 GLADIUS	650	2009	>	010FSU018	
SV 1000 S	1000	2003	2007	010FSU010	
SV650 N/S	650	2003	2008	010FSU010	
TL 1000 S	1000	1997	>	010FSU002	
<b>TRIUMPH</b>					
DAYTONA 675	675	2006	>	010FTR001	
SPEED TRIPLE 1050	1050	2005	2010	010FTR002	
STREET TRIPLE 675	675	2007	>	010FTR001	
ST 1050	1050	2005	>	010FTR002	
TIGER 1050	1050	2005	>	010FTR002	
<b>YAMAHA</b>					
XCITY	125	2005	>	010FYA017	
XCITY	250	2005	>	010FYA017	
XMAX	125	2005	>	010FYA017	
XMAX	250	2005	>	010FYA017	
XT 660 R/X	660	2004	>	010FYA010	
YZF 125R	125	2009	>	010FYA018	
MT03	660	2007	>	010FYA010	
FZS FAZER 600	600	1998	2003	010FYA001	
FZ6	600	2004	2006	010FYA014	
FZ6 S2	600	2007	>	010FYA014	
FZ8	800	2010	>	010FYA015	
FZS FAZER 1000	1000	2001	2005	010FYA003	
FZ1 FAZER 1000	1000	2006	2008	010FYA015	
FZ1 1000	1000	2006	2008	010FYA015	
T MAX	500	2001	2007	010FYA009	
T MAX	500	2008	>	010FYA011	
YZF R6	600	1999	2005	010FYA005	
YZF R6	600	2006	2007	010FYA008	
YZF R6	600	2008	>	010FYA013	
YZF R1	1000	1998	2001	010FYA002	
YZF R1	1000	2004	2006	010FYA006	
YZF R1	1000	2007	2008	010FYA012	
YZF R1	1000	2009	>	010FYA016	





**CAVALLETTI  
STANDS**

Althea  
Racing

DUCA  
CORSE

## Cavalletti

### Stands



modello - model	codice - code	€
Coppia cavalletti sfilabili h 380 / 560 in alluminio Pair of aluminium extensible stands h 380 / 560	RSA002	



modello - model	codice - code	€
Coppia cavalletti sfilabili h 670 / 940 in alluminio Pair of aluminium extensible stands h 380 / 560	RSA003	



modello - model	codice - code	€
Cavalletto anteriore centrale in ferro Iron front triple tree lift	RSF035	





modello - model	codice - code	€
Cavalletto anteriore in ferro Iron front stand	RSF008	



modello - model	codice - code	€
Cavalletto posteriore in ferro a 2 ruote con forchette Iron rear stand with 2 wheels and forks	RSF036	



modello - model	codice - code	€
Cavalletto posteriore in ferro a 2 ruote con forchette Iron rear stand with 2 wheels and forks	 RSF037F	
Cavalletto posteriore in ferro a 2 ruote con pattini Iron rear stand with 2 wheels and sliding blocks	 RSF037P	
Cavalletto posteriore in ferro a 2 ruote rulli Iron rear stand with 2 wheels and rollers	 RSF037R	

## Ricambi per cavalletti

## Stands spare parts

## Forchette - Forks



codice - code	a coppia - for pair
RSF23	

## Pattini - Sliding blocks



codice - code	a coppia - for pair
RSF24	

## Rulli - Rollers



codice - code	a coppia - for pair
RSF25	

## Ruote - Wheels



codice - code	a coppia - for pair
RW001	

## Cavalletti

### Stands



modello - model	codice - code	€
Cavalletto anteriore in ferro Iron front stand	RSF22	



modello - model	codice - code	€
Cavalletto posteriore in ferro con forchette Iron rear stand with forks	RSF21	
Cavalletto posteriore in ferro con pattini Iron rear stand with sliding blocks	RSF21P	
Cavalletto posteriore in ferro con rulli Iron rear stand with rollers	RSF21R	

#### Cavalletto posteriore monobraccio in ferro Iron one armed rear stand



modello - model	∅	codice - code	€
DUCATI 848 - 748	25,7	RSF005	
DUCATI 1098	40,6	RSF004	
DUCATI 996 - 998	25,7	RSF005	
DUCATI S2R - S4R	25,7	RSF005	
DUCATI MONSTER	25,7	RSF005	
DUCATI MULTISTRADA	25,7	RSF005	
DUCATI HYPERMOTARD	25,7	RSF005	
HONDA CB 1000 R	28,4	RSF002	
HONDA VFR 800	28,4	RSF002	
MV BRUTALE	42,7	RSF001	
MV F4	42,7	RSF001	
TRIUMPH	26,8	RSF003	
<b>NEW</b> BMW R 1200 GS	53,5	RSF011	

#### Perno per cavalletto monobraccio in ferro Pin for iron one armed rear stand



∅ perno - ∅ pin	codice - code	€
42,7	RSF26	
28,4	RSF27	
26,8	RSF28	
40,6	RSF29	
25,7	RSF30	
53,5	RSF037	



**RACING & BOX**

## Accessori box

Box accessories



modello - model	codice - code	€
Carrello porta cerchi in alluminio Aluminium rims carrier	RSA13	



modello - model	codice - code	€
Rastrelliera porta cerchi in alluminio con 10 postazioni Aluminium rims rack with 10 positions	RSA14	



modello - model	codice - code	€
Banco portamoto in carbonio 2100mm x 650mm Carbon bench table 2100mm x 650mm	RSA001	



modello - model	codice - code	€
Seggiolino officina in ferro Iron workshop stool	RSF20	

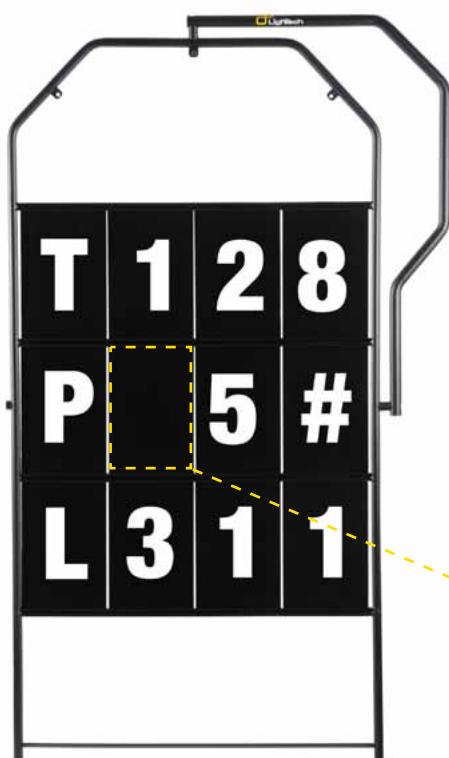

modello - model	codice - code	€
Carrello pit-lane in alluminio Aluminium pit-lane trolley	RSA004	

**NEW**

modello - model	codice - code	€
Pitboard in acciaio inox Stainless steel pitboard	TTG001	

completa di 50 tabelle / with 50 tables

**NEW**

modello - model	codice - code	€
Pitboard in titanio Titan pitboard	TTG002	

completa di 50 tabelle / with 50 tables

## Saponette

Knee sliders



Colin Edwards



articolo - article	codice - code	€
		a coppia - for pair
Rain	SAPR001	
Colori disponibili: rosso / Available colours: red		
	Ricambio / Spare part	RSAPR001



articolo - article	codice - code	€
		a coppia - for pair
Filler	SAPF	
Colori disponibili: rosso, blu, bianco, nero, giallo Available colours: red, blue, white, yellow, black		



articolo - article	codice - code	€
		a coppia - for pair
Nuke	SAPN	
Colori disponibili: nero Available colours: black		



## Saponette

### Knee sliders



articolo - article	codice - code	€
		a coppia - for pair
Dropper	SAPDRO	

Colori disponibili: rosso, blu, bianco, nero, giallo  
Available colours: red, blue, white, yellow, black



articolo - article	codice - code	€
		a coppia - for pair
Leather	SAPL	

Cuoio - Leather



articolo - article	codice - code	€
		a coppia - for pair
Fire titan nuke	SAPT	

nuke con inserti in titanio - Nuk with titanium

## Neoprene per sella

### Neoprene for racing seat



codice - code	€
NSR01	

## Serbatoio rifornimento rapido

Fast fuel canister

NEW



Colori disponibili: rosso, oro, nero.  
Available colours: red, gold, black.



con foro centrato - with central hole



modello - model	codice - code	colore serbatoio fuel canister colour	€
5 LITRI / litres	SER01	inox	
10 LITRI / litres	SER02	inox	



con foro decentrato - with not central hole

modello - model	codice - code	colore serbatoio fuel canister colour	€
5 LITRI / litres	SER04	inox	
10 LITRI / litres	SER05	inox	



**RACCORDERIA  
FRENO  
BRAKE PARTS**

## Raccorderia freno

### Brake parts



modello - model	misura - measure	codice - code	€
Bullone singolo Single banjo bolt	M 10 X 1	VF11	
	M 10 X 1,25	VF1251	



modello - model	misura - measure	codice - code	€
Bullone doppio Double banjo bolt	M 10 X 1	VF12	
	M 10 X 1,25	VF1252	



modello - model	misura - measure	codice - code	€
Bullone singolo con spurgo Single banjo bolt with bleeder	M 10 X 1	VF11SP	
	M 10 X 1,25	VF1251SP	



modello - model	misura - measure	codice - code	€
Bullone doppio con spurgo Double banjo bolt with bleeder	M 10 X 1	VF12SP	
	M 10 X 1,25	VF1252SP	



modello - model	codice - code	€
Ogiva ottone Brass hose holder	OG	



modello - model	codice - code	€
Raccordo tre vie completo di ogiva e dadi Three-way joint set with hose holders and nuts	RAC3	



modello - model	codice - code	€
Rondelle alluminio Aluminium washers	RONA	



modello - model	codice - code	€
Tubo teflon maglia d'acciaio Teflon hose steel covered	TUBT	



modello - model	codice - code	€
Occhiello dritto con dado Bajo fitting set	OCD	



modello - model	codice - code	€
Occhiello 25° con dado 25° elbow banjo fitting set	OC25	



modello - model	codice - code	€
Occhiello 45° con dado 45° elbow banjo fitting set	OC45	



modello - model	codice - code	€
Occhiello 90° con dado 90° elbow banjo fitting set	OC90	



modello - model	misura - measure	codice - code	€
Spurgo Bleeder	M6	SPM6	
	M7	SPM7	
	M8	SPM8	
	M 10 x 1	SPM10	



modello - model	codice - code	€
Dado per occhielli Banjo nut	DAD	



modello - model	codice - code	€
Guaina termoretraibile Thermoshrinking	GUAINA	
Disponibile nei colori: blu, rosso, giallo, trasparente, nero Available cours: blue, red, gold, transparent, black		



modello - model	codice - code	€
Spiralina nera Black- spiral thermoshrinking	SPI	



modello - model	codice - code	€
Raccorderia freno, guaina, tubo in treccia Brake screws, thermo shrinking, teflon hose	KITSBK	

Lorenzo Baroni



Jorge Lorenzo

Flavio Gentile



Ben Spies



Federico Sandi





modello - model	codice - code	€
Espositore da terra · 65x200 cm	EXP001	
Floor display stand - 65x200 cm		



modello - model	codice - code	€
Espositore da banco · formato 28x42 cm	EXP002	free
Table display stand - 28x42 cm		

## Condizioni generali di vendita

### PREZZI

I prezzi esposti nel catalogo sono espressi in euro, IVA esclusa.

### TRASPORTO

Il trasporto avverrà tramite corriere e le spese di trasporto verranno evidenziate e addebitate in fattura.

### TEMPI E MODALITÀ DI CONSEGNA

La consegna dei prodotti viene normalmente assicurata entro 15 giorni dal ricevimento dell'ordine. I prodotti Lightech® possono essere consegnati in tutto il mondo.

### RESO MERCE

Nell'eventualità che il cliente riceva un prodotto che presenta delle difettosità o anomalie rispetto a quanto ordinato, Egli dovrà:

1. Entro 5 giorni lavorativi dalla ricezione della consegna, informare il Servizio Clienti Lightech a mezzo fax oppure via e-mail (sales@lightech.it), per ricevere le istruzioni circa la restituzione del prodotto difettoso.

### PAGAMENTO

Per ordini inferiori ai € 100,00, il pagamento della merce avverrà in contrassegno e oltre alle spese di trasporto verranno addebitate anche le spese di incasso.

### MARCHI

I seguenti marchi registrati con i nomi: Aprilia®, Ducati®, Honda®, Kawasaki®, Mv Agusta®, Suzuki®, Triumph®, Yamaha® sono di proprietà delle rispettive Case e vengono qui utilizzati a solo titolo descrittivo.

### VARIAZIONI AL CATALOGO

Lightech srl, si riserva la facoltà di apportare variazioni sia al presente catalogo che alle presenti condizioni di vendita, in qualsiasi momento e senza preavviso.

### AVVERTENZE

I prodotti Lightech® sono stati progettati e realizzati per l'utilizzazione in ambiti agonistici. Lightech® non si assume pertanto alcuna responsabilità per un eventuale uso non corretto dei propri prodotti.

### INFORMAZIONE SUI PRODOTTI

Tutti gli articoli inseriti nel catalogo vengono prodotti in Italia presso gli stabilimenti della Lightech srl. Le fotografie, le informazioni e le schede tecniche che illustrano i prodotti e le caratteristiche tecniche, sono di proprietà esclusiva della Lightech srl.

### CONTROVERSIE E RESPONSABILITÀ

Queste Condizioni Generali sono regolate dalle Leggi Italiane. Per qualsiasi controversia relativa alla validità, interpretazione o esecuzione delle medesime, la competenza territoriale è quella di Treviso.

**Colori disponibili: rosso, blu, oro, nero, silver, indaco, ad eccezione di dove diversamente indicato.**

## Sales conditions prices

### PRICE

The prices on catalogue are done in euro. VAT not included.

### TRANSPORT

By express courier with transport charges on your account in invoice.

### DELIVERY TIMES AND WAY

Normaly our delivery times are 15 days from the receiving of the order. Lightech® products can be delivered all over the world.

### RETURNS

We accept claims within 5 days from the receiving of the goods. Returns will be accepted only if authorized by Lightech srl. So you have to inform us by fax, by e-mail (sales@lightech.it) or by phone giving us details about the goods ordered, invoice number and reasons for the returning of them.

### PAYMENT

On your choice between:

PRO-FORMA INVOICE, to pay by advanced bank transfer or Credit Card;

CASH ON DELIERY, with bank charges on invoice.

### TRADEMARK

Aprilia®, Ducati®, Honda®, Kawasaki®, Mv Agusta®, Suzuki®, Triumph®, Yamaha® are registered trademarks, here used only as a reference.

### CHANGES

Lightech will be able to change the prices and sales conditions of this catalogue at any moment also without notice for commercial and technical reasons.

### NOTICE

All Lightech® products are designed and realized only for agonistic use and in a closed circuit.

### INFORMATION ABOUT PRODUCTS

All articles on this catalogue are made in Italy. We produce all in our company in Santa Lucia di Piave (TV). The photos and the informations present in the catalogue are Lightech srl property. All rights reserved.

### LEGISLATION

This contract shall come under Italian laws.

The territorial jurisdiction is Treviso.

**Colours available: red, light blue, gold, black, silver, dark blue, except where other colours are indicated.**











Lightech srl  
Via Serenissima, 15  
31025 S. Lucia di Piave (TV)

Tel. +39 0438 453010  
Fax +39 0438 655919

info@lightech.it  
www.lightech.it